

Sound level meter

DB 200



I - Introduction.....	5
II – Vocabulary.....	6
III – Sound level meter presentation.....	7
III-1 Overview.....	7
III-2 Presentation of the screen-keyboard group.....	8
IV – Settings.....	9
IV-1 Configuration.....	9
IV-2 I/O.....	9
IV-3 Contrast / Backlight.....	10
IV-4 Autonomy.....	10
IV-5 Instrument.....	10
IV-6 About.....	11
V – Make some measurements.....	11
V-1 Conventional sound level meter function.....	11
V 1-1 – Adjustment prior to measurement.....	11
V 1-2 – Launch the measurement.....	11
V 1-3 – During the measurement.....	11
V-2 Conventional sound level meter with storage function.....	12
V 2-1 – Adjustment prior to measurement.....	12
V 2-2 – Launch the measurement.....	12
V 2-3 – During the measurement.....	12
V 2-4 – Stop the measurement.....	13
V 2-5 – Store data.....	13
V-3 Conventional and integrating-averaging sound level meter function.....	14
V 3-1 – Adjustment prior to measurement.....	14
V 3-2 – Launch the measurement.....	14
V 3-3 – During the measurement.....	14
V 3-4 – Stop the measurement.....	15
V 3-5 – Store data.....	15
V-4 Integrating-averaging sound level meter with storage function.....	16
V 4-1 – Adjustment prior to measurement.....	16
V 4-2 – Launch the measurement.....	16
V 4-3 – During the measurement.....	16
V 4-4 – Stop the measurement.....	17
V 4-5 – Store data.....	17
V-5 Calculate two sound sources.....	18
V 5-1 – Adjustment prior to measurement.....	18
V 5-2 – Make calculation of two sound sources.....	18
V 5-3 – Store data.....	19
V-6 Determine a sound source among two.....	19
V 6-1 – Adjustment prior to measurement.....	20
V 6-2 – Make the measurement.....	20
V 6-3 – Store data.....	20
V-7 Sound level meter in I/O mode.....	21
V 7-1 – Launch a measurement in I/O mode.....	21

VI – Read the stored files.....	22
VI-1 Access to files.....	22
VI-2 Read all data file.....	22
VI 2-1 – L-St file mode.....	22
VI 2-2 – L-Leq file mode.....	23
VI 2-3 – Leq-St file mode.....	24
VI 2-4 – S1 + S2 file mode.....	24
VII – Transferring files to PC.....	25
VIII – Reset memory.....	25
IX – Directions for use and the sound level meter maintenance.....	26
IX-1 Use caution.....	26
IX-2 Usage tip.....	26
IX-3 Calibration.....	26
IX-4 Maintenance.....	28
IX-5 Regular checking	28
IX-6 Replace batteries.....	28
IX-7 Replace batteries with a battery pack.....	28
IX-8 Load battery.....	28
IX-9 Adapter.....	28
X – Information during operation.....	29
X-1 Overload of input stages.....	29
X-2 Power.....	29
XI – Technical features.....	30
XI-1 Microphone.....	30
XI 1-1 – Plug.....	30
XI 1-2 – Frequency response type, pitch of 0° on the housing of the sound level meter.....	30
XI-2 Windscreen.....	30
XI-3 Measured and displayed values.....	31
XI-4 A – C – Z weightings and free field response.....	31
XI-5 Metrology.....	32
XI 5-1 – Main features.....	32
XI-6 Plugs and connections.....	33
XI 6-1 – I/O Interface	33
XI 6-2 – Transfer plug / load / main voltage adaptor.....	33
XI-7 Memory and storage autonomy.....	34
XI-8 Power and storage autonomy.....	34
XII – Packaging and accessories.....	35
XII-1 Supplied with.....	35
XII-2 Optional.....	35
XIII – LDB200 software.....	35

I – Introduction

The **DB200** sound level meter is an acoustic measurement instrument with main features of a conventional and integrating-averaging sound level meter.

With its memory, **DB200** sound level meter stores measurement datasets. Then they are transferred to a computer and processed through **LDB200** software.

According to international standards, sound level meter calculates and displays on its graphical backlight LCD-screen values used for a fast and complete study of the noise environment.

To simplify and make nice its use, 5 measurement modes have been preselected :

- **Mode 1** : Conventional sound level meter (See p.11)
- **Mode 2** : Conventional sound level meter with storage (See p.12)
- **Mode 3** : Conventional and integrating-averaging sound level meter (See p.14)
- **Mode 4** : Integrating-averaging sound level meter with storage (See p.16)
- **Mode 5** : Sound level meter « calculator » of two sound sources (See p18)

In the different modes, in addition to measured values, the sound level meter can display :

- results for a better definition of the acoustic environment :

Maximum and minimum values, peak values, statistics distribution of measured levels

- Indications required for the proper validation of the measurement :

Presence and percentage of overload input stages, duration of the measurement

- other information :

Battery autonomy, remaining measuring capacity

The sound level meter also communicates with an automaton through I / O plugs :

- 0-10 V DC analog output
- Control bit activated as per pre-programmed threshold
- Launching and stop of measurement by the automaton

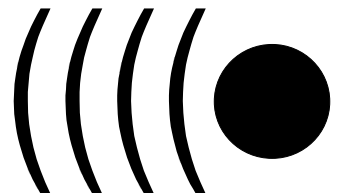

II – Vocabulary

The terms and abbreviations listed below will be used throughout this user manual.

L : represents the measurement mode: conventional sound level meter

L-St : represents the measurement mode : conventional sound level meter with storage function. The sound pressure level is stored into the memory at a sampling rate which is defined and planned.

L-Leq : represents the measurement mode : conventional and integrating-averaging. Values are measured simultaneously.

L-St : represents the measurement mode : integrating-averaging sound level meter with storage function The equivalent continuous sound level on the logging time (DI) is stored into the memory.

S1+S2 : denomination for measuring or calculating the levels of 2 sound sources.

LXeq : X-weighted equivalent continuous sound level on the logging time or on the total time of the measurement.

LXeqM : Maximum X-weighted equivalent continuous sound level on the logging time, on the total time of the measurement.

LXeqm : Minimum X-weighted equivalent continuous sound level on the logging time, on the total time of the measurement.

LXE : X-weighted sound exposure level.

LXY : X-weighted acoustic pressure level ; time weighting : Y

LXYmax : Maximum X-weighted sound pressure level ; time weighting : Y

LXYmin : Minimum X-weighted sound pressure level ; time weighting : Y

LUpK : U-weighted peak sound level.

Echant. : time between two successive storages of the sound pressure level into the memory, also called : **Sampling rate**.

DI : Programmable logging time for the calculation of the equivalent continuous sound level stored into the memory, also called : elementary integration time.

X : **generic marking** for frequency weightings, A – C or Z standardized (L, Leq, LE values)

U : **generic marking** for frequency weightings, C or Z standardized (Lpk values)

Y : **generic marking** for time weightings with : « **F** » for Fast, « **S** » for Slow or « **I** » for Impulse.

Man : manual mode of measurement launching

I/O : Launching mode of the measurement controlled by I/O plugs.

SXX : order number of the measurement sessions. Limited to 25.

RST : reset of calculations of maximum or minimum values memorized – erasing of measurement session or of the whole memory.

Sto. : storage of measurement session into the memory.

S1 : name for measuring or calculating the equivalent continuous sound level of a first sound source.

S2 : name for measuring or calculating the equivalent continuous sound level of a second sound source.

S1+S2 : name for measuring or calculating the equivalent continuous sound level of the two sound sources.

00/00:00:00 : format of the measurement time in Days/hours:minutes:seconds

00/00:00 : format of the measurement time in Days/hours:minutes

00:00:00 : format of the measurement time in Days/hours:minutes:seconds or format of the current time

18/11 : format of date

00:00 : format of current time in hours/minutes

Pond. : A, C or Z frequency weightings

Cte : time weighting or time constant : Fast – Slow - Impulse

S/S : integration time controlled in Manuel mode : **Start/Stop**

C.CI : free field correction term in calibration mode.

Corr. : corrective term of nominal benefit in calibration mode.

L01 – L10 – L50 – L90 – L95 : Normalised statistics distribution, used in environmental studies

III – Presentation of the sound level meter

III 1 – Overview

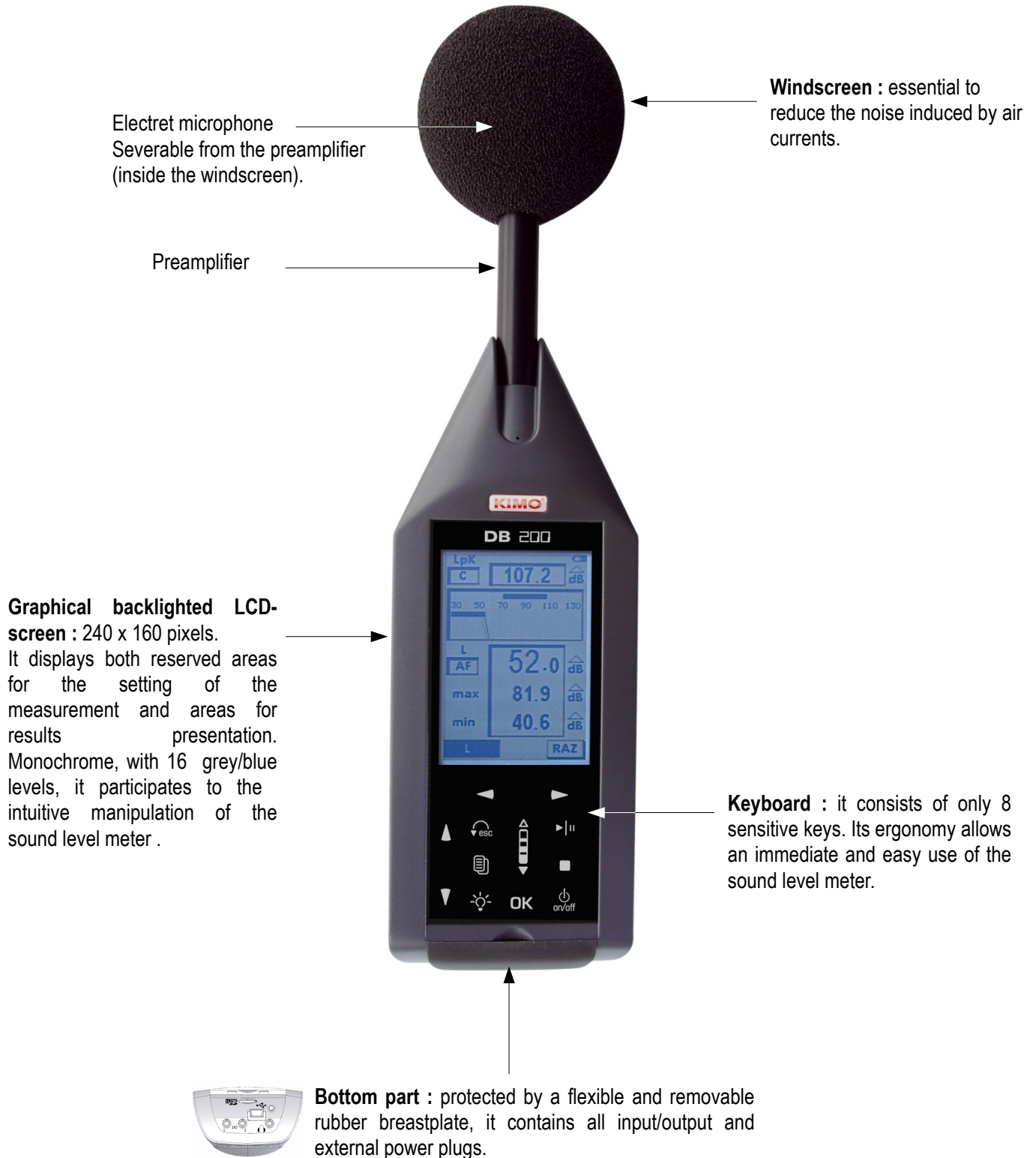

The back of the instrument contains a battery compartment door, a threaded hole for mounting on a tripod, a location for the nameplate and a location for the calibration label.

III 2 – Presentation of the screen-keyboard group

The **screen/keyboard** group gives to the instrument a modern ergonomy. It mainly participates to the quick familiarization of the sound level meter.

A press, a touch or a very light finger slipped on keyboard icon is enough to trigger the corresponding action of the sensitive key.

The **measurement configuration** is made by moving a reversed video cursor in reserved areas, then by choosing the concerned parameter or function.

For instance :

- Time weighting choice : **Slow, fast or Impulse.**
- Frequency weighting choice : **A, C or Z.**
- Measurement mode choice : **L, L-St, L-Leq or Leq-St.**

Reserved areas appear according to two 3D type formats :

- **Inner shadow to the frame** : simulates a shifted back area in which parameters can be modified or displayed measurement results.
- **External shadow to the frame** : simulates a shifted forward area in which different propositions of the menu can be chosen to go to an other configuration or validation screen.

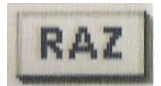

A push on each arrow moves the cursor on the horizontal left-right axis.



A push on each arrow moves the cursor on the vertical up-down axis.



scrolling knob key : increases or decreases suggestions in the area according the principle of front or back circular permutation. The finger must slide from an arrow to the other one, simulating a scroll wheel action. From the bottom to the top to increase or from the bottom to the top to back to the previous proposal.



Validate a suggestion or an action to lead present in an outer shaded frame.



Go to the main menu to return to the previous screen.



Exit a menu screen to return to the previous screen.



Launch a measurement, then pause it if necessary .



Finally stop measurement





Enable-disable the backlight.



On-Off

IV – Settings

From the  key a screen lists the different settings or informations about the instrument.
To have access to one of those screens, scroll with the scrolling knob key and validate with **OK** key.
To quit each screen and back to main menu, use  key.

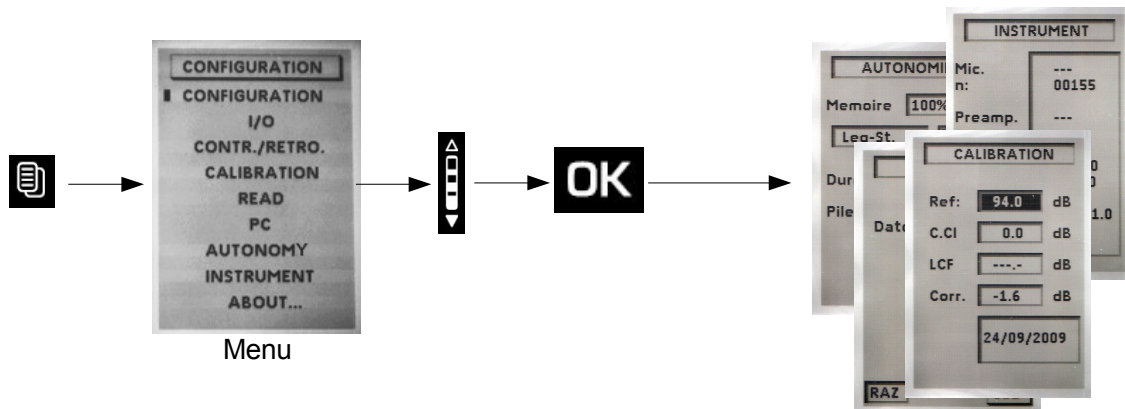

IV 1 – Configuration

This screen allows configuration for some functions. To have access to those functions :
Press  key then choose **CONFIGURATION** with the scrolling knob key and **OK** key to validate.

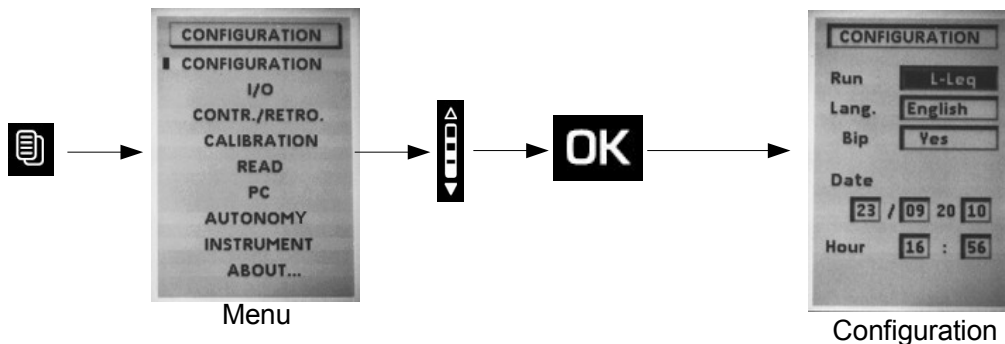

From this screen, use arrow keys to move the cursor in the desired area and modify with the scrolling knob key the proposition.
Various parameters to adjust are :

- **Run** : systematic measurement mode when starting the device : **L, L-St, L-Leq, Leq-St** or **S1+S2**.
- **Lang.** : user language : **French** or **English**.
- **Bip** : the presence or absence of tone when pressing on the keyboard. The beep disappears by itself if it interferes with the measurement.
- **Date / Hour** : Set date and time

To return to main screen, press .

IV 2 – I/O

The I/O input/output allows to connect 2.5 mm jacks. It is located at the bottom of the unit behind the rubber breastplate.
I/O 1 corresponds to **input** for the launch and stop measurement from an industrial controller and is for measurement modes **L-St, L-Leq** and **Leq-St**. Launching of the measurement is made for a continuous high level and stopping the measurement is made for a continuous low level.

I / O 1 also corresponds to the detection output compared to a preset sound level and is for all modes of measurement. A high level appears in output when the value of the acoustic pressure level reaches and exceeds a certain value.

For this type of output following items must be configured :

- The level type: choose **L, Leq** or **LPK** depending on the mode of measurement.
- Programming with scrolling knob key the desired level of detection by 1 dB steps.
- Set a timer for maintaining the continuous signal detection after sub-overshoot sound level (from 1s to 10s by 1s pitch).

I/O 2 : DC continuous analogue output : 0-10V for connection to a recorder or industrial controller.

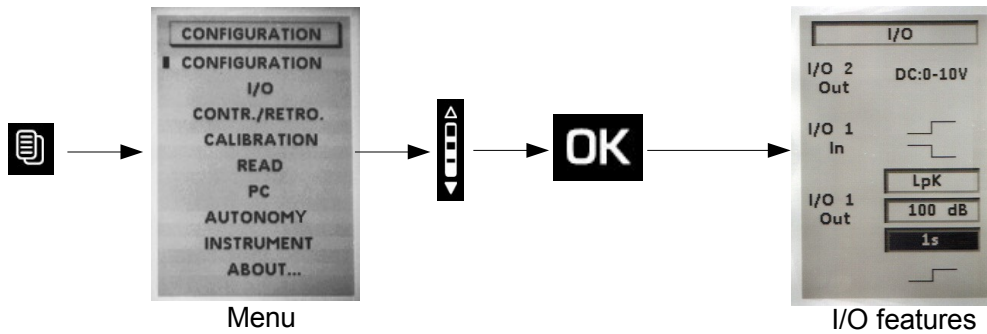

IV 3 – Contrast - backlight

To optimize reading of the display:

- Position the cursor on **Cont.** and adjust the contrast by choosing with scrolling knob key a level of 1 to 7.
- Position the cursor on **Retro.** and adjust backlight by choosing with scrolling knob key a level of 1 to 3.

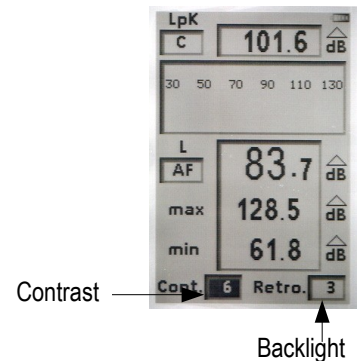

IV 4 – Autonomy

Autonomy provides information on the remaining memory capacity and allows time measurement according to the chosen method of measurement and acquisition speed measurement (logging time or sampling rate).

- Select measurement mode among **L-St** or **Leq-St**.
- Specify the sampling rate or logging time according to the method of measurement used.

The measurement time is calculated automatically based on the remaining memory capacity. It is immediately compared to the remaining capacity of the power system : batteries, battery or AC adapter.

A warning appears in case of incompatibility between measurement time and power capacity.

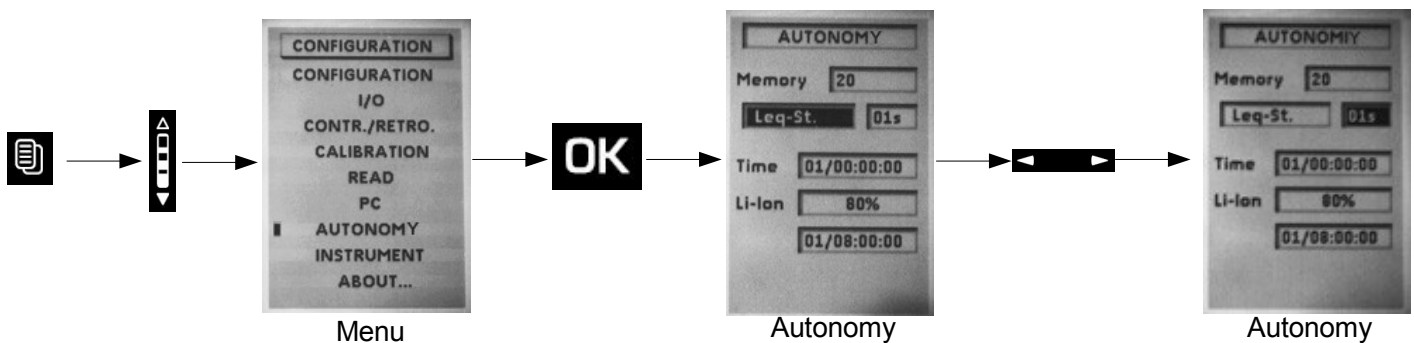

IV 5 – Instrument

This screen reminds main components of the sound level meter:

- microphone and its serial number
- sound level meter housing
- version number of the firmware.

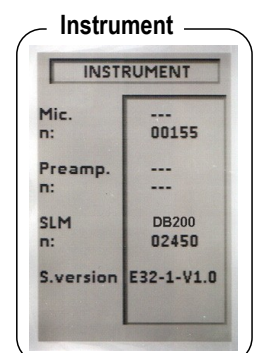

IV 6 – About

This screen shows the various European standards and the accuracy class of the instrument.
It also specifies the date of the last checking and recalled next.

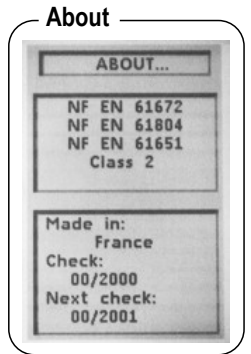

V – Make some measurements

V 1 – Conventional sound level meter function

The sound level meter processes the signal and displays sound pressure and at the same time following informations :

- Temporally weighted sound pressure level.
- Maximum and minimum values of levels on the measurement time.
- Level of maximum peak sound level on the measurement time.

V 1-1 – Adjustment prior to measurement

1 – Select **L mode** : move the cursor with arrow keys to **1** and select '**L**' with the scrolling knob key.

2 – Select the weighting frequency and the time weighting.

For each weighting frequency, the sound level meter proposes the measurement according to three time weightings : **Fast (F)** – **Slow (S)** – **Impulse (I)**. Possible choices are :

A frequency weighting : **LAF** – **LAS** – **LAI**

C frequency weighting : **LCF** – **LCS** – **LCI**

Z frequency weighting : **LZF** – **LZS** – **LZI**

Place the cursor with arrow key on the area **2** and select with scrolling knob identified measurement criteria among the possibilities listed above.

3 – Select the weighting frequency of peak level of sound pressure : move the cursor with the arrows to **3** and select **C** or **Z** with the scrolling knob key.

V 1-2 – Launch the measurement

The measurement is immediate, yet it is interrupted and reset with each change.

V 1-3 – During measurement

During the measurement, two actions are possible :

- Reset memorized levels.
- Fix the measurement thanks to Pause function.

To reset all the values :

Press **OK** icon, **RAZ** function is activated and concerns :

- **LAF** maximum and minimum levels
- Value of the maximum peak pressure
- Informations about overload

Pause function allows to stop the current measurement to avoid an unwanted event or to make a manual record of results.

Press **PAUSE** icon to stop the measurement then press it again to resume measuring.

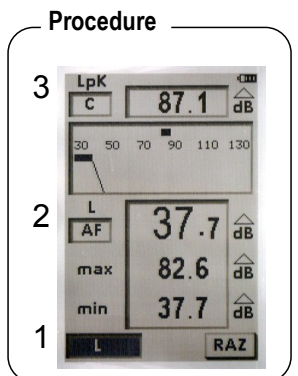

RAZ activation



Pause

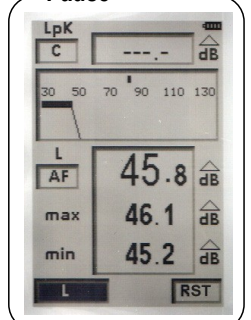

When the sound level meter is paused, no action is specified in the "Peak" at the top of the screen.

*See p.29 for further detail on overload function.

V 2 – Conventional sound level meter with storage function

The sound level meter processes the sound pressure signal and stores with a sampling rate results in a saved memory.

Data measured and stored at a sampling rate :

- Temporally weighted sound pressure level
- Maximum and minimum levels on the measurement time.
- Level of maximum peak sound pressure on the measurement time.

Sampling rate :

Stored data is made at a rate to choose from:

1s, 2s, 3s, 5s, 10s, 15s, 30s, 60s.

V 2-1 – Adjustment prior to measurement

1 – Select **L-St mode** : move the cursor with arrow keys to **1** and select '**L-St**' with the scrolling knob key.

2 – Select the weighting frequency and the time weighting.

For each weighting frequency, the sound level meter proposes the measurement according to three time weightings : **Fast (F)** – **Slow (S)** – **Impulse (I)**. Possible choices are :

A frequency weighting : **LAF** – **LAS** – **LAI**

C frequency weighting : **LCF** – **LCS** – **LCI**

Z frequency weighting : **LZF** – **LZS** – **LZI**

Place the cursor with arrow key on the area **2** and select with scrolling knob identified measurement criteria among the possibilities listed above.

3 – Select the weighting frequency of peak level of sound pressure : move the cursor with the arrows to **3** and select **C** or **Z** with the scrolling knob key.

4 – Select sampling rate : move the cursor to **4** and select with scrolling knob key among 1s, 2s, 3s, 5s, 10s, 15s, 30s, 60s.

V 2-2 – Launch the measurement

In **manual** mode : directly press icon 

In **I/O** mode : see chapter « Launching a measurement in I/O mode »

V 2-3 – During measurement

During measurement, **three screens** inform the current measurement. They are accessible through the scrolling knob key.

E1 : it is the main screen that displays the instantaneous measurements.

E2 : This screen contains results of values that will be stored in memory at the end of measurement:

- **LUpk** : maximum peak level of sound pressure.
- **LXYmax** : maximum value of sound pressure level weighted temporally met since the beginning of the measurement.
- **LXYmin** : minimum value of sound pressure level weighted temporally met since the beginning of the measurement.
- **D** : measurement time in DD/HH:MM:SS
- **%** : percentage of saturation of the input stage.
- **Statistics indices** : L01 – L10 – L50 – L90 – L95. They are calculated from stored samples.

Procedure

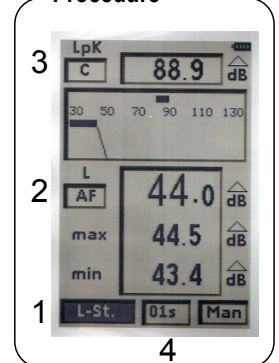

Screen 1

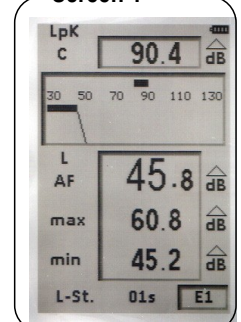

Screen 2

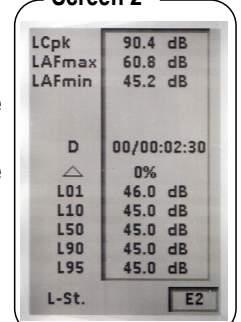

E3 : this screen reminds the general format of the session of measurement:

- **Start** : date of measurement start
- **End** : date of measurement end (here, not entered because measurement is still ongoing.)
- **Time** : measurement time (here, not entered because measurement is still ongoing.)
- **Mode** : measurement mode type (here, L-Stock)
- **Weig.** : weighting frequency type (here, A)
- **Cst** : time weighting (here, F)
- **Lpk** : weighting frequency type of the peak sound level (here, C)
- **Samp.** : sampling rate (here, 01s)

Screen 3

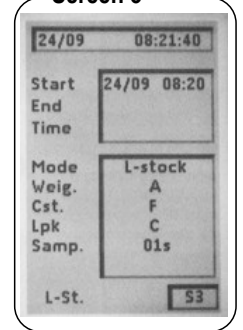

V 2-4 – Stop the measurement

We stopped the measurement manually through the  pictogram.



- The **manual** command (Start - Stop) has priority over the **I/O** command (even if the initial choice is a start from the **I/O** command).
- The pause function is inoperative.

V 2-5 – Store data

At the end of the measurement, in **manual** mode, a screen of all results is displayed. It is then possible to :

- Accept measurements and store them : move the cursor on **Sto.** and press once on OK key to confirm. A banner displays the storage phase.

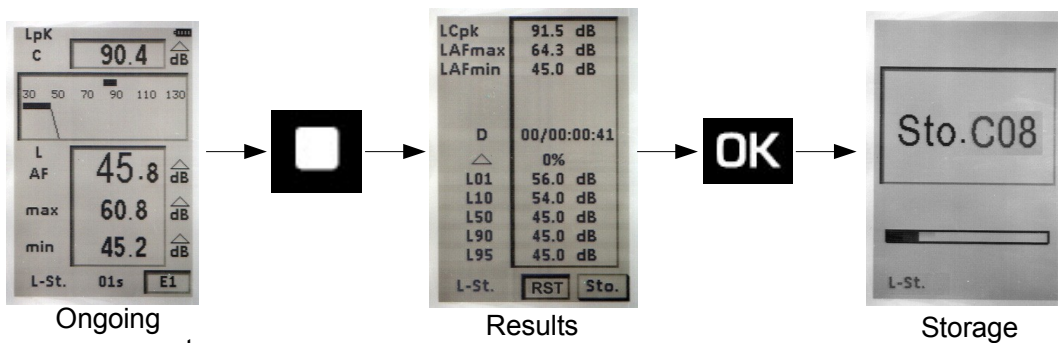

- Reject measurements and not store them : move the cursor on **RST** and press **twice** on OK key to confirm. A banner displays the phase of suppression of data.

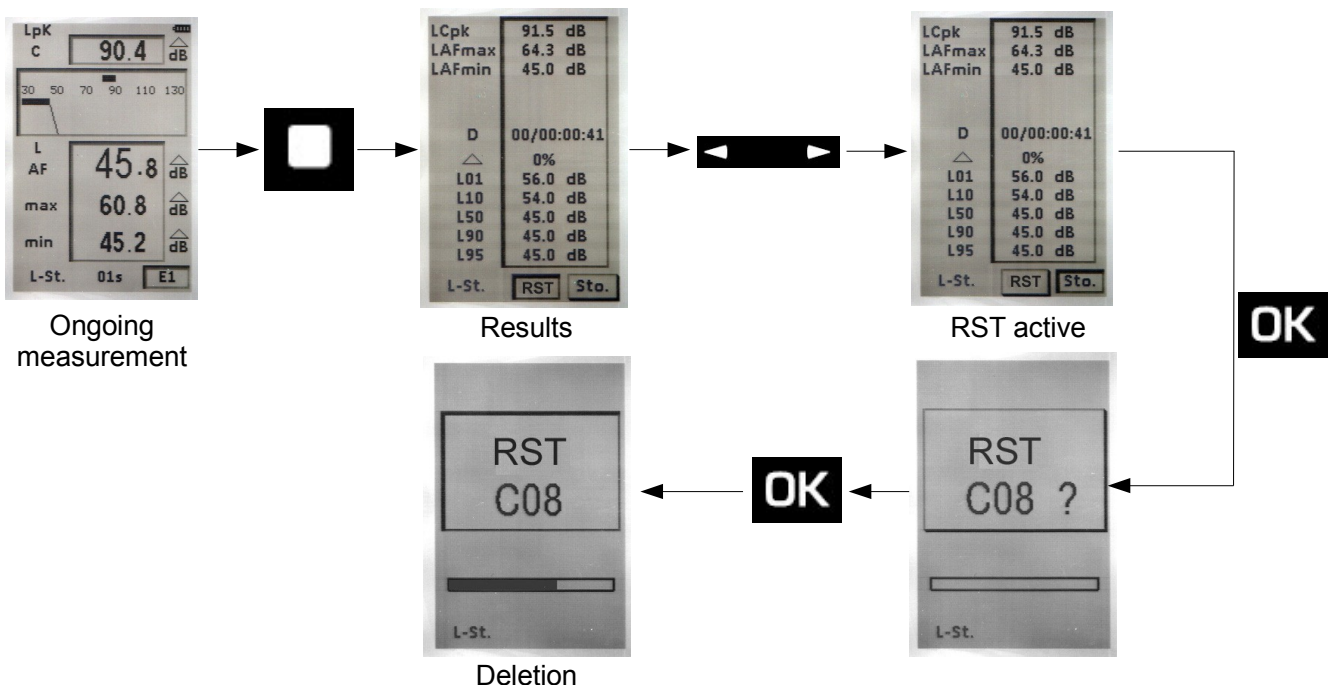

V 3 – Classical sound level meter and averager integrator function

The sound level meter processes the signal sound pressure and simultaneously provides the following information :

- **LXY** : the sound pressure level weighted temporally.
- **LXYmax and LXYmin** : maximum and minimum values of the levels on measurement time.
- **Lupk** : level of maximum peak of sound pressure on the measurement time.
- **LXeq** : equivalent continuous level of acoustic pressure frequency weighted on measurement time.

V 3-1 – Adjustment prior to measurement

1 – Select **L-Leq mode** : move the cursor with arrow keys to **1** and select '**L-Leq**' with the scrolling knob key.

2 – Select the weighting frequency and the time weighting.

For each weighting frequency, the sound level meter proposes the measurement according to three time weightings : **Fast (F)** – **Slow (S)** – **Impulse (I)**. Possible choices are :

A frequency weighting : **LAF** – **LAS** – **LAI**

C frequency weighting : **LCF** – **LCS** – **LCI**

Z frequency weighting : **LZF** – **LZS** – **LZI**

Place the cursor with arrow key on the area **2** and select with scrolling knob identified measurement criteria among the possibilities listed above.

3 – Select the weighting frequency of peak level of sound pressure : move the cursor with the arrows to **3** and select **C** or **Z** with the scrolling knob key.

Procedure

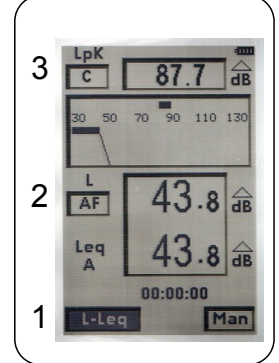

V 3-2 – Launch the measurement

In **manual** mode : directly press **▶** icon ,the timer starts and shows the measurement time. This time is limited to 24 hours.

In **I/O** mode : see chapter « Launching a measurement in I/O mode ».

V 3-3 – During measurement

During measurement, **three screens** inform the current measurement. They are accessible through the scrolling knob key.

E1 : it is the main screen that displays the instantaneous measurements.

- **LXY** : the sound pressure level weighted temporally.
- **LXeq** : equivalent continuous level of sound pressure frequency weighted on measurement time.
- **LUpk** : level of maximum peak of sound pressure on the measurement time.
- **Duration of the measurement** expressed in DD / HH: MM: SS

E2 : This screen contains results of values that will be stored in memory at the end of measurement :

- **LUpk** : level of maximum peak of sound pressure on the measurement time.
- **LXYmax** : maximum value of sound pressure level weighted temporally met since the beginning of the measurement.
- **LXYmin** : minimum value of sound pressure level weighted temporally met since the beginning of the measurement.
- **LXeq** : equivalent continuous level of acoustic pressure frequency weighted on measurement time.
- **LXE** : level of exposure to sound frequency weighted
- **D** : Measurement time expressed in DD / HH: MM: SS
- **%** : percentage of saturation of the input stage.

Screen 1

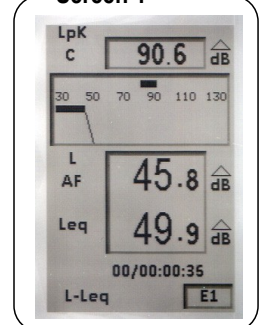

Screen 2

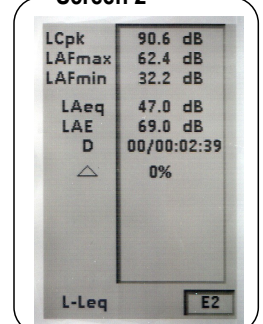

E3 : this screen reminds the general format of the session of measurement:

- Date of measurement start
- Date of measurement end : not entered because measurement is still ongoing.
- Measurement time : not entered because measurement is still ongoing.
- Measurement mode : L-Leq
- Frequency weighting for L and Leq : Weig.
- Time weighting for L : Cst
- Integration time for Leq : S/S (Start/ Stop mode)
- Frequency weighting of the level of pressure peak for L : Lpk

Screen 3

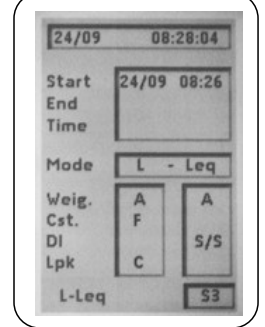

V 3-4 – Stop the measurement

We stopped the measurement manually through the  pictogram.



- The **manual** command (Start - Stop) has priority over the **I/O** command (even if the initial choice is a start from the **I/O** command).
- The pause function is inoperative.

V 3-5 – Store data

At the end of the measurement, in **manual** mode, a screen of all results is displayed. It is then possible to :

- Accept measurements and store them : move the cursor on **Sto.** and press once on OK key to confirm. A banner displays the storage phase.

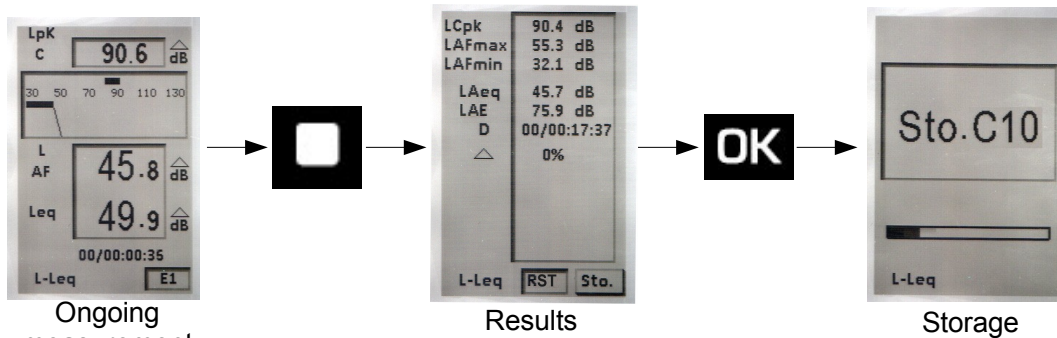

- Reject measurements and not store them : move the cursor on **RST** and press **twice** on OK key to confirm. A banner displays the phase of suppression of data.

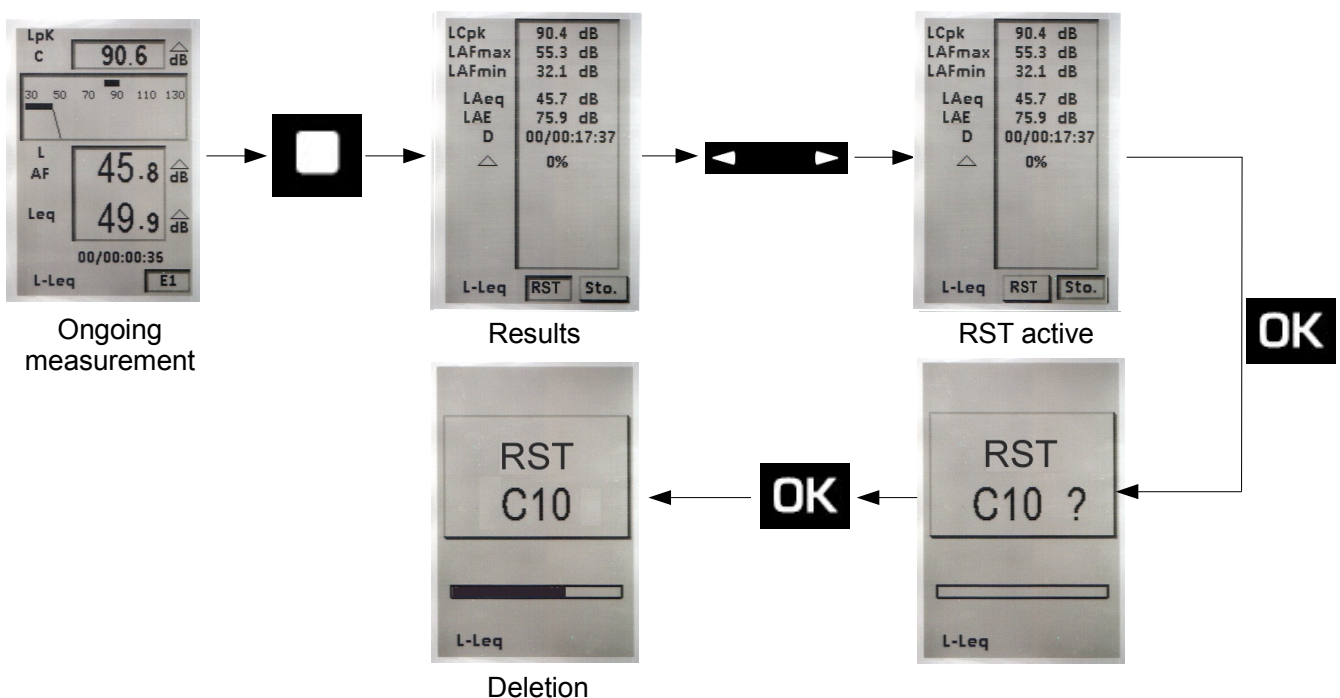

V 4 – Sound level meter and averager integrator with storage function

The sound level meter processes the acoustic signal for each elementary integration time and stores results in a saved memory.

Measured and stored data for each integration time:

- **LXeq, DI** : equivalent continuous sound level of acoustic pressure on the logging time and frequency weighted.
- **LUpk** : level of maximum peak of sound pressure on the elementary integration time.
- Measurement time expressed in DD/HH:MM:SS

Integration time :

Data storage is made according to logging time (DI) to choose from : 1s, 2s, 3s, 5s, 10s, 15s, 30s, 60s.



In order to have permanent control of the sound pressure level before the launch of measurement, the sound level meter calculates and displays the equivalent continuous level of acoustic pressure on a logging time of 0.5s.

V 4-1 – Adjustment prior to measurement

1 – Select **Leq-St mode** : move the cursor with arrow keys to **1** and select '**Leq-St**' with the scrolling knob key.

2 – Select the weighting frequency.

Possible choices are : **A** frequency weighting - **C** frequency weighting - **Z** frequency weighting.

Place the cursor with arrow key on the area **2** and select with scrolling knob **A**, **C** or **Z**.

3 – Select the weighting frequency of peak level of sound pressure : move the cursor with the arrows to **3** and select **C** or **Z** with the scrolling knob key.

4 – Select the DI logging time :

Place the cursor on 4 and select with the scrolling knob among : 1s, 2s, 3s, 5s, 10s, 15s, 30s, 60s.

V 4-2 – Launch the measurement

In **manual** mode : directly press icon ,the timer starts and shows the measurement time

In **I/O** mode : see chapter « Launching a measurement in I/O mode ».

V 4-3 – During measurement

During measurement, **three screens** inform the current measurement. They are accessible through the scrolling knob key.

E1 : it is the main screen that displays the instantaneous measurements.

- **LXeq0,5** : equivalent continuous level of acoustic pressure over a systematic integration time of 0,5s.
- **LXeqDI** : equivalent continuous level of acoustic pressure over the scheduled elementary integration time
- **LXeq** : equivalent continuous level of acoustic pressure on ongoing measurement time.
- **LUpk** : level of maximum peak of sound pressure on the measurement time.
- **Measurement time** expressed in DD/HH:MM:SS

Procedure

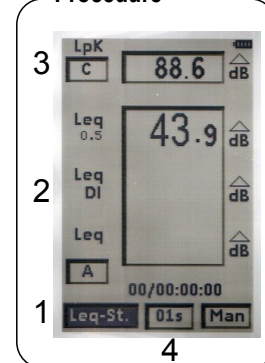

Screen 1

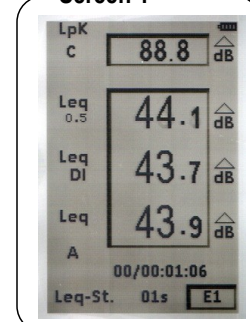

E2 : This screen contains results of values that will be stored in memory at the end of measurement :

- **LUpk** : level of maximum peak of sound pressure on the measurement time.
- **LXeqM** : maximum value of equivalent continuous sound pressure level of all elementary integration times.
- **LXeqm** : minimum value of equivalent continuous sound pressure level of all elementary integration times.
- **LXeq** : equivalent continuous level of sound pressure on the overall measurement time.
- **LXE** : level of exposure to sound frequency weighted.
- **D** : measurement time in DD/HH:MM:SS
- **%** : percentage of saturation of the input stage.
- **Statistics indices** : L01 – L10 – L50 – L90 – L95. They are calculated from stored samples.

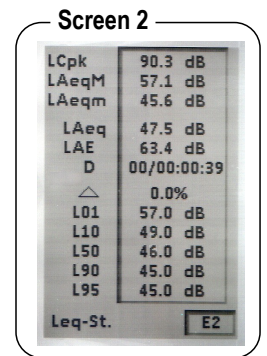

E3 : this screen reminds the general format of the session of measurement:

- Date of measurement start
- Date of measurement end : not entered because measurement is still ongoing.
- Measurement time : not entered because measurement is still ongoing.
- Measurement mode : Leq-St
- Frequency weighting for Leq : Weig.
- Elementary integration time for Leq : DI
- Frequency weighting of the level of pressure peak for L : Lpk

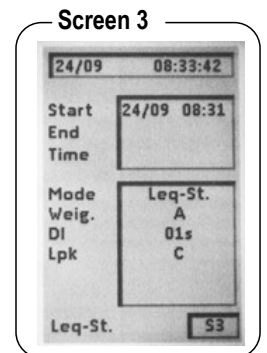

V 4-4 – Stop the measurement

We stopped the measurement manually through the  pictogram.



- The **manual** command (Start - Stop) has priority over the **I/O** command (even if the initial choice is a start from the **I/O** command).
- The pause function is inoperative.

V 4-5 – Store data

At the end of the measurement, in **manual** mode, a screen of all results is displayed. It is then possible to :

- Accept measurements and store them : move the cursor on **Sto.** and press once on OK key to confirm. A banner displays the storage phase.

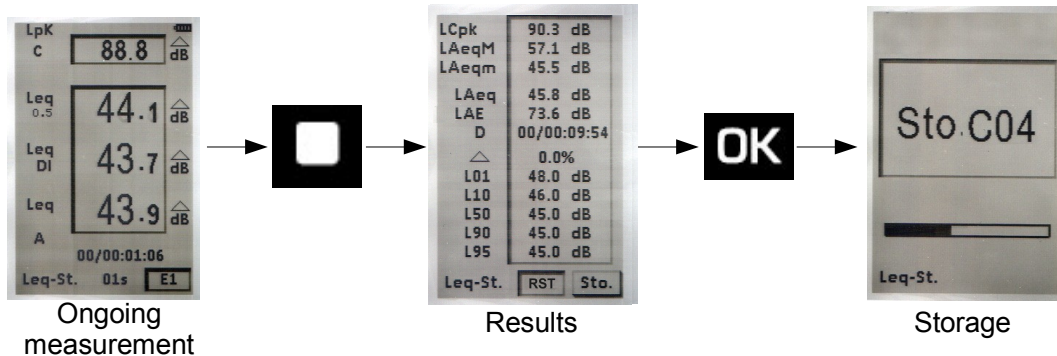

- Reject measurements and not store them : move the cursor on **RST** and press **twice** on OK key to confirm. A banner displays the phase of data deletion.

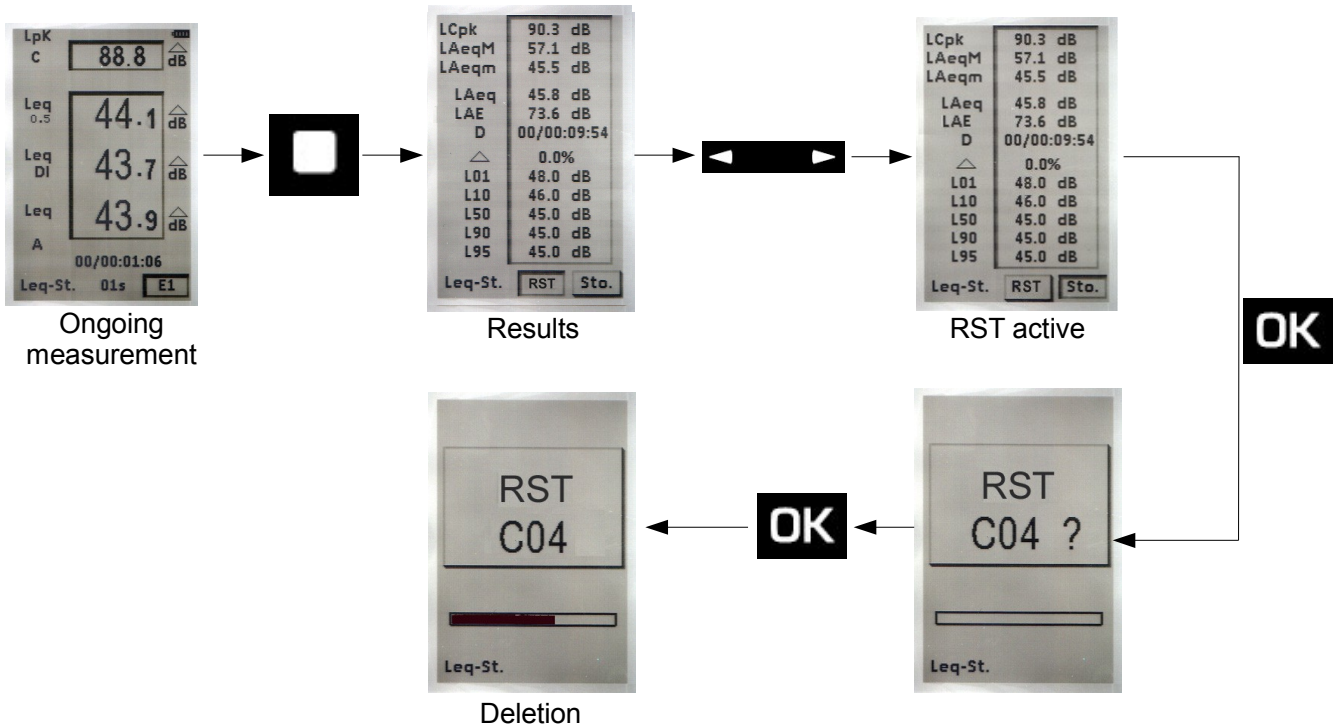

V 5 – Calculate two sound sources

The sound level meter processes the acoustic signal of several sound sources over a time left to the free initiative of the operator. The measured value here is the equivalent continuous level over this time.

V 5-1 – Adjustment prior to measurement

1 – Select **S1 + S2 mode** : move the cursor with arrow keys in 1 and select « **S1 + S2** » with the scrolling knob key.

2 – Select the frequency weighting.
Possible choices are : **A** frequency weighting - **C** frequency weighting - **Z** frequency weighting (LIN).

Place the cursor with arrow keys on the area 2 and select with scrolling knob **A**, **C** or **Z**.

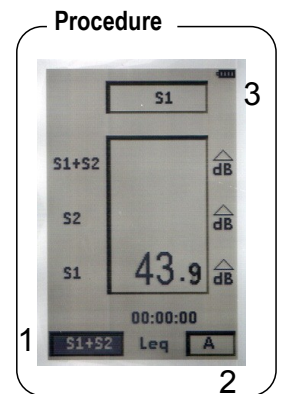

V 5-2 – Make calculation of two sound sources

- Measure **S1** sound source
 - Move the cursor to 3 and select **S1** with the scrolling knob key then launch the measurement with
 - Stop the measurement when it seems representative (stabilized evolution of the L_Xeq value).
- Measure **S2** sound source :
 - Move the cursor to 3 and select **S2** with the scrolling knob key then launch the measurement with

The measure will stop by itself after time T previously chosen for the measurement of the S1 source.

The equivalent continuous level calculated from the two combined sources is displayed in front of 'S1 + S2'.

V 5-3 – Store data

At the end of the measurement a screen of all results is displayed. It is then possible to :

- Accept measurements and store them : move the cursor on **Sto.** and press once on OK key to confirm. A banner displays the storage phase.

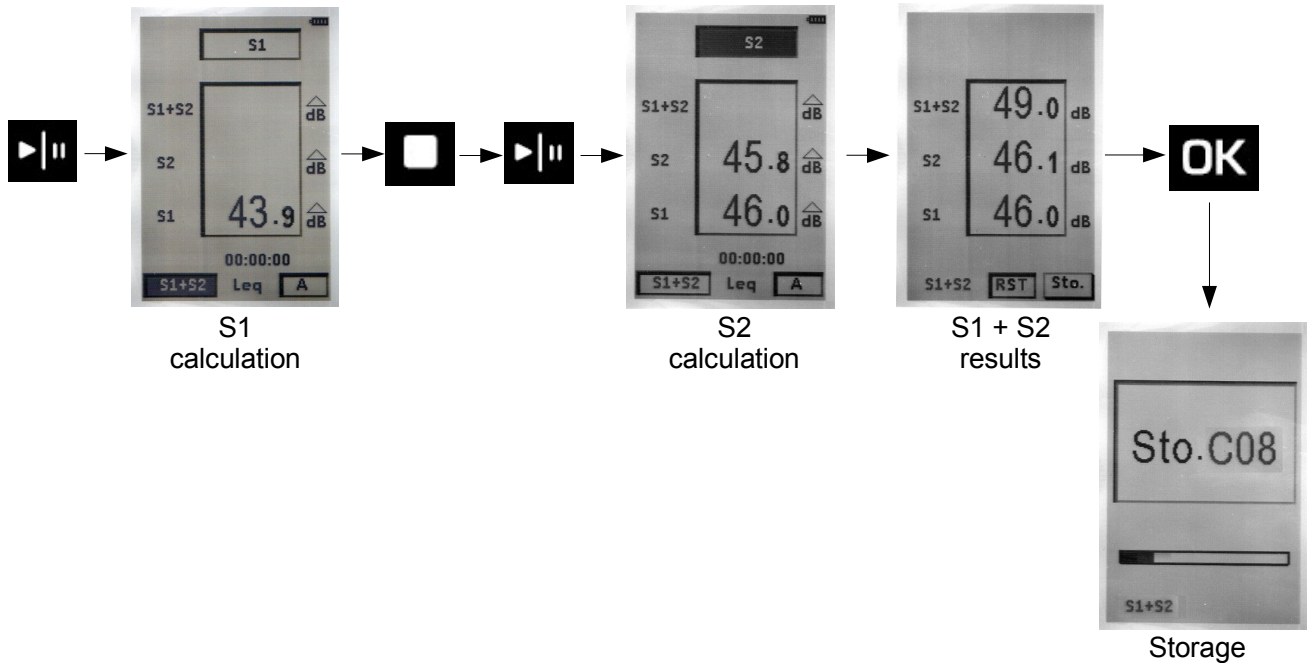

- Reject measurements and not store them : move the cursor on **RST** and press **twice** on OK key to confirm. A banner displays the phase of data deletion.

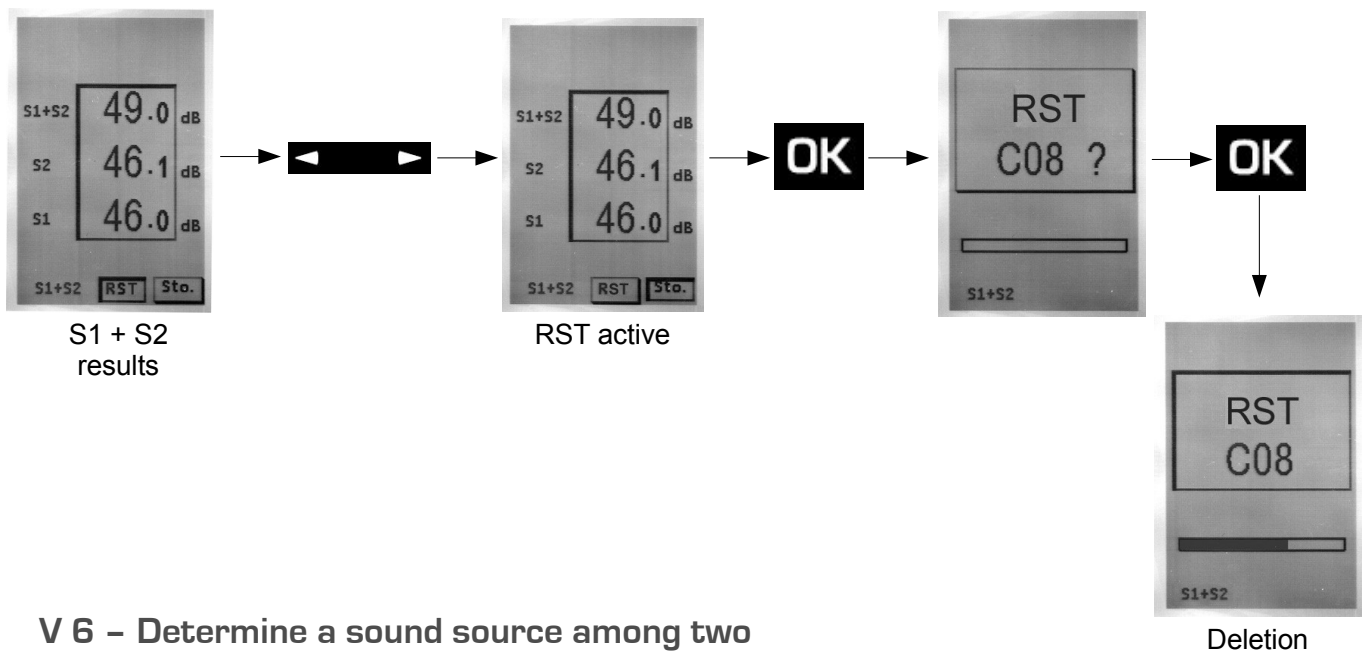

V 6 – Determine a sound source among two



The determination of a sound source among a set of two can not run unless the operator can interrupt one of the two sources, the aim being to estimate the sound level of a source without the presence of the other source.

Example : outdoor heat pump in a background noise of day.

Estimate the sound level of a heat pump without the background noise of day, to estimate the possible nuisance of the heat pump in a noise environment less noisy as the one present the night.

V 6-1 – Adjustment prior to measurement

1 – Choose the **S1 + S2 mode** : place the cursor with the arrow keys to 1 and select 'S1 + S2' with the scrolling knob key.

2 – Select the frequency weighting.

Possible choices are : **A** frequency weighting - **C** frequency weighting - **Z** frequency weighting (LIN).

Place the cursor with arrow keys on the area **2** and select with scrolling knob **A**, **C** or **Z**.

V 6-2 – Make the measurement

• Move the cursor to 3 and select « **S1 + S2** » with the scrolling knob key to measure the two sound sources.

In the example, outdoor heat pump (**S1**) in a background noise of day (**S2**).

• Launch the measurement with the  pictogram.

• Stop the measurement when it seems representative (stabilized evolution of the LXeq value) with the  pictogram.

• Stop the **S1** sound source (in the example, heat pump).

• Launch the measurement of the **S2** sound source (background noise) with the  pictogram.

*Measurement of the **S2** sound source will stop by itself after time T chosen for the measurement of the **S1+S2** sound source and the **S1** and **S2** sound source level is displayed on the sound level meter.*

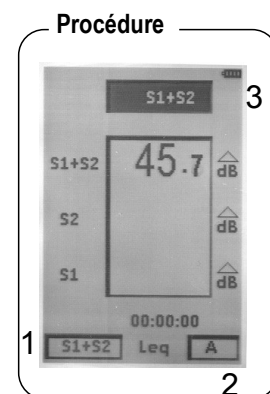

In case improper handling and/or of calculation impossibility, result will not be displayed.

Example : S1+S2 level is lower than S1, so S2 can not be calculated. Lines will appears on the screen instead of numbers.

V 6-3 – Store data

At the end of the measurement it's possible to store data.

• Accept measurements and store them : move the cursor on **Sto.** and press once on OK key to confirm. A banner displays the storage phase.

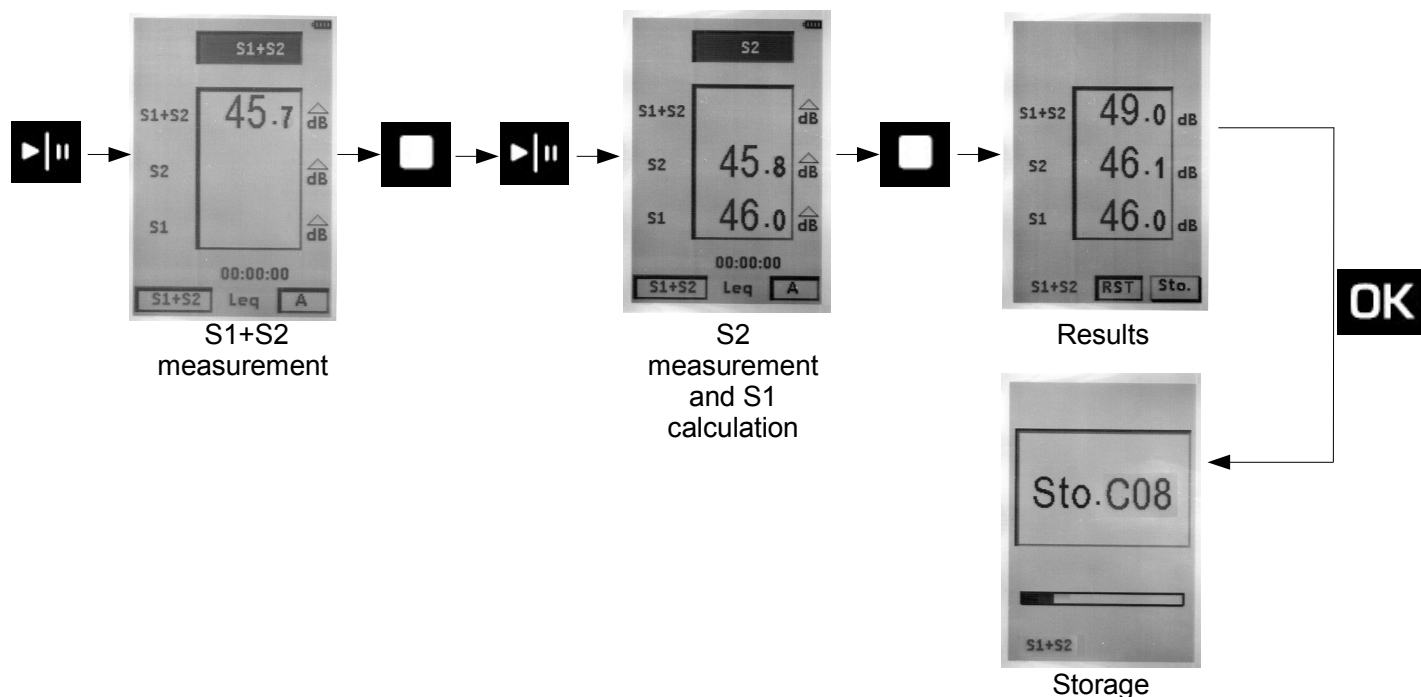

• Reject measurements and not store them : move the cursor on **RST** and press **twice** on OK key to confirm. A banner displays the phase of data deletion.

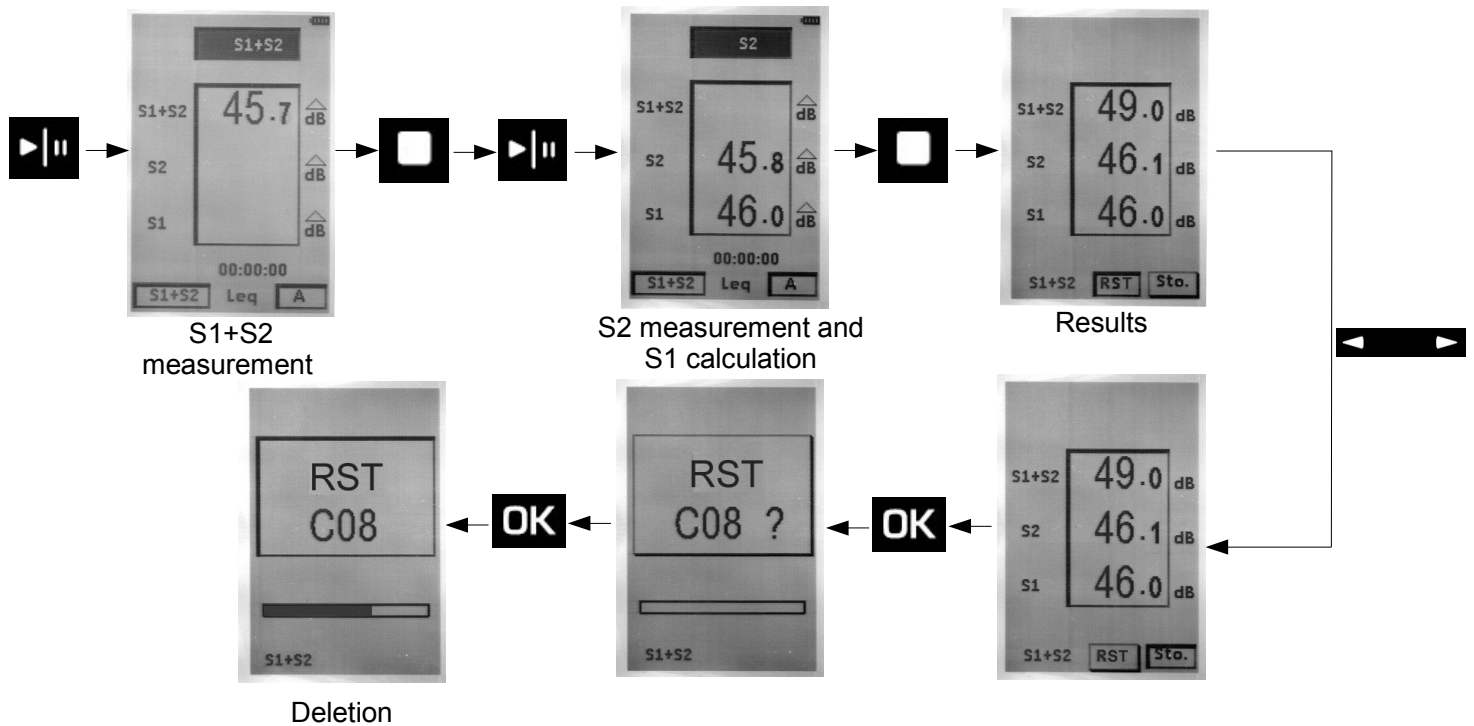

V 7 – Sound level meter in I/O mode

The sound level meter can be part of a monitoring chain which is controlled by an industrial controller. So sequences of measurement are directly launched by orders from the controller.

In addition, it delivers on programming a continuous signal of sound level detection. This signal can then be interfaced with any system of visual or audible warning.

V 7-1 – Launch a measurement in I/O mode

In **L-St**, **L-Leq** or **Leq-St** mode, select **I/O** icon at the bottom right of the screen at the time of adjustments prior to measurement.

- Press **OK** key to go to the screen which reminds launching and stopping measurement conditions : measurement begins when a high continuous level appears and measurement stops when returning to the low level.
- Press **OK** key to back to main measurement screen.

From that moment, sound level meter waits for the electrical signal on the I/O plug to start measurement.

At the end of the measurement, storage of the measurement session in the sound level meter memory will be done systematically.



• The **manual** command (Start - Stop) has priority over the **I/O** command. It will be always possible to manually launch or stop measurement.

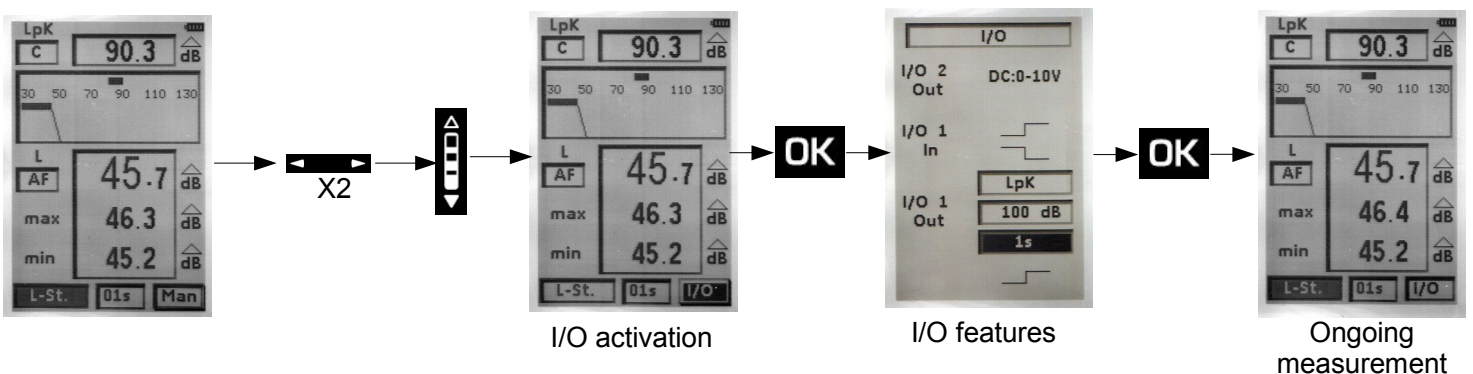

VI – Read the stored files

After a controlled stopping of the measurement and a data storing, it's possible to see on the screen measurement dataset results.

VI 1 – Access to files

- Press **Menu** key then select **Read** then **OK**.

The first stored file is displayed.

- Scroll stored files with the scrolling knob key.

Each file is identified by a serial number (type C01) and a filename (format : S01_1811LPF). This file name will appear when uploading to a computer.

For easy identification, the shown screen includes all measurement configuration :

- **Mode** : L-St, L-Leq, Leq-St, S1 + S2.
- **According to the mode** : different frequency and time weightings, logging time, sampling rate, date and time...

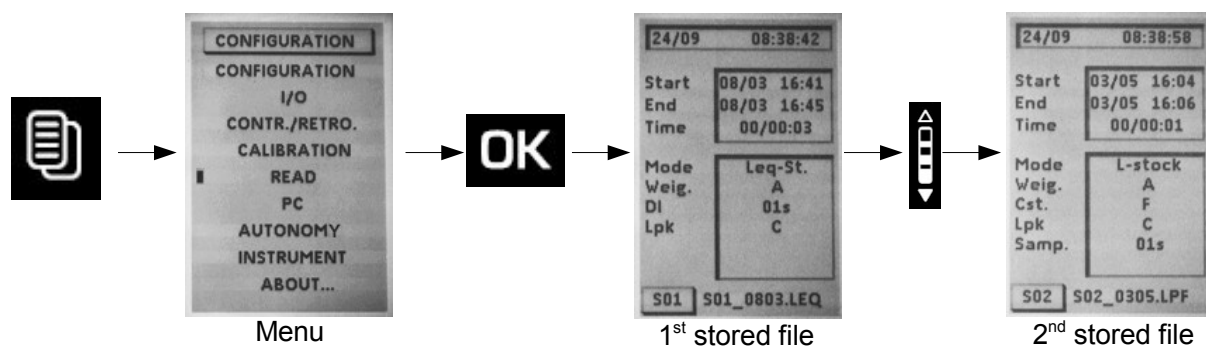

VI 2 – Read all data file

VI 2-1 – L-St mode file

When the file has been identified by its identification number:

- > Press **OK** key to access to **E1** main screen results.

- **LUpk** : level of maximum peak of sound pressure
- **LXYmax** : maximum value of sound pressure level weighted temporally met since the beginning of the measurement.
- **LXYmin** : minimum value of sound pressure level weighted temporally met since the beginning of the measurement.
- **D** : Measurement time expressed in DD / HH: MM: SS.
- **%** : percentage of saturation of the input stage.
- **Statistics indices** : L01 -L10 – L50- L90- L95

- > With scrolling knob key, go to **E2** screen which reminds measurement configuration.

- Date of measurement start
- Date of measurement end
- Measurement time expressed in DD / HH: MM: SS.
- Measurement mode : L-St
- Frequency weighting : Weig.
- Time weighting : Cst
- Frequency weighting of the level of peak pressure : LpK
- Sampling rate : Samp.

> Press **Esc** key to quit this file and back to file selection main screen.

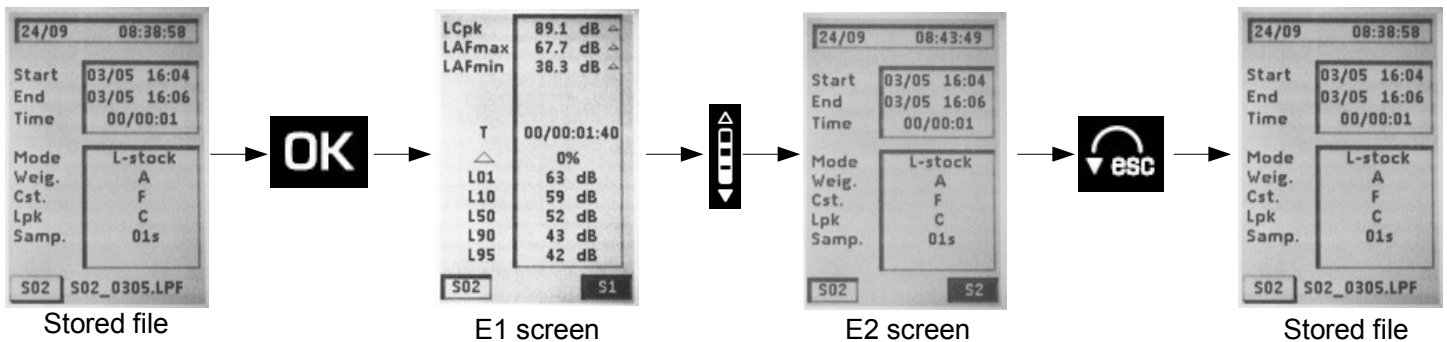

VI 2-2 – L-Leq mode file

When the file has been identified by its identification number:

> Press **OK** key to access to **E1** main screen results.

- **LUpk** : level of maximum peak of sound pressure
- **LXYmax** : maximum value of sound pressure level weighted temporally met since the beginning of the measurement.
- **LXYmin** : minimum value of sound pressure level weighted temporally met since the beginning of the measurement.
- **LXeq** : equivalent continuous level of acoustic pressure frequency weighted on measurement time.
- **LXE** : level of exposure to sound frequency weighted
- **D** : measurement time expressed in DD / HH: MM: SS.
- **%** : percentage of saturation of the input stage.

> With scrolling knob key, go to **E2** screen which reminds measurement configuration.

- Date of measurement start
- Date of measurement end
- Measurement time expressed in DD / HH: MM: SS.
- Measurement mode : L-Leq
- Frequency weighting for L and Leq : Weig.
- Time weighting for L : Cst
- Integration time for leq : S/S (**Start/Stop** mode)
- Frequency weighting of the level of peak pressure for L : LpK

> Press **Esc** key to quit this file and back to file selection main screen.

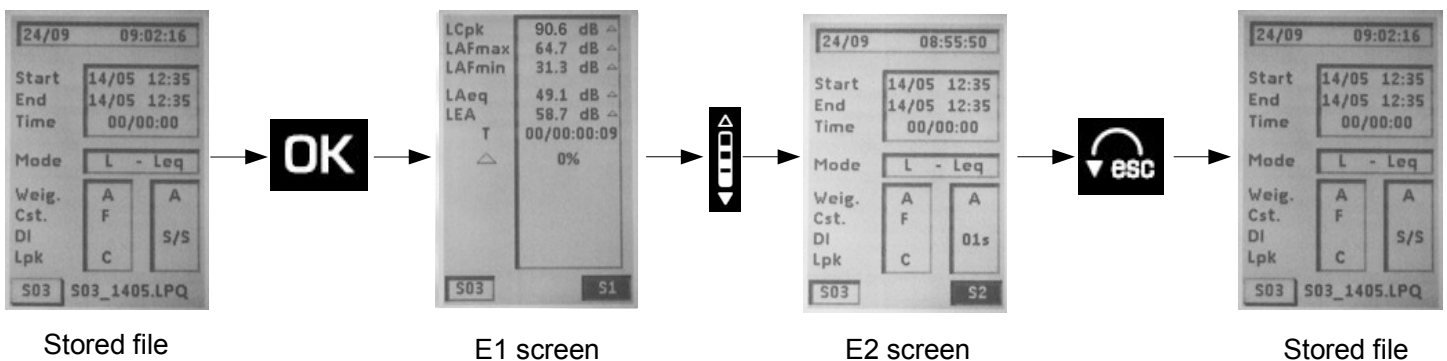

VI 2-3 – Leq-St mode file

When the file has been identified by its identification number:

- > Press **OK** key to access to **E1** main screen results.
 - **LUpk** : level of maximum peak of sound pressure on the measurement time.
 - **LXeqM** : maximum value of equivalent continuous sound pressure level of all elementary integration times.
 - **LXeqm** : minimum value of equivalent continuous sound pressure level of all elementary integration times.
 - **LXeq** : equivalent continuous level of sound pressure on the overall measurement time.
 - **LXE** : level of exposure to sound frequency weighted.
 - **D** : measurement time in DD/HH:MM:SS
 - **%** : percentage of saturation of the input stage.
 - **Statistical indices** : L01 – L10 – L50 – L90 – L95. They are calculated from stored samples.
- > With scrolling knob key, go to **E2** screen which reminds measurement configuration.
 - Date of measurement start
 - Date of measurement end
 - Measurement time expressed in DD / HH: MM: SS.
 - Measurement mode : Leq-St
 - Frequency weighting for Leq : Weig.
 - Elementary integration time for Leq : DI
 - Frequency weighting of the level of peak pressure for L : LpK
- > Press **Esc** key to quit this file and back to file selection main screen.

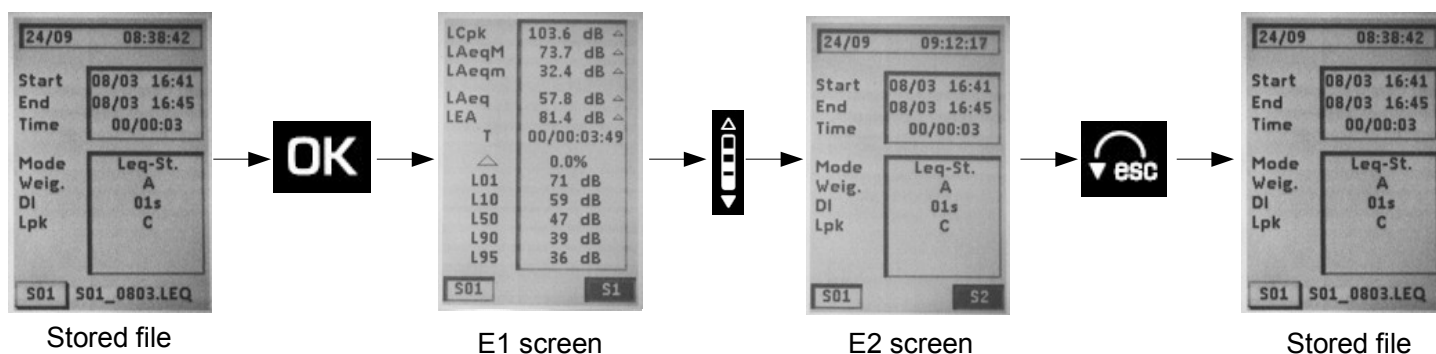

VI 2-4 – S1+S2 mode file

When the file has been identified by its identification number, you access to the main single screen of results. It shows :

- **S1 + S2** : equivalent continuous level of both sources
- **S2** : equivalent continuous level of **S2** sound source
- **S1** : equivalent continuous level of **S1** sound source
- Frequency weighting of the equivalent continuous level
- Measurement time for the calculation of equivalent continuous level
- > Press **Esc** key to quit this file and back to file selection main screen.

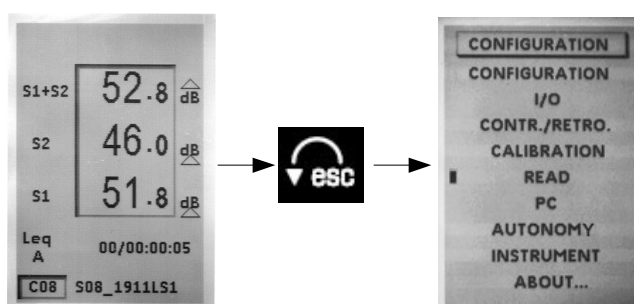

VII – Transfer files to PC

This function allows to transfer data towards a computer through a USB cable. **LDB200** software has been previously installed on the computer.

- Connect the instrument to the PC through the USB cable.
- Go to « PC » screen of the sound level meter : from the menu icon, select **PC** then **OK**.
- Press **OK** key again to activate **USB** icon.

The connection to the PC is shown on the screen of the sound level meter.

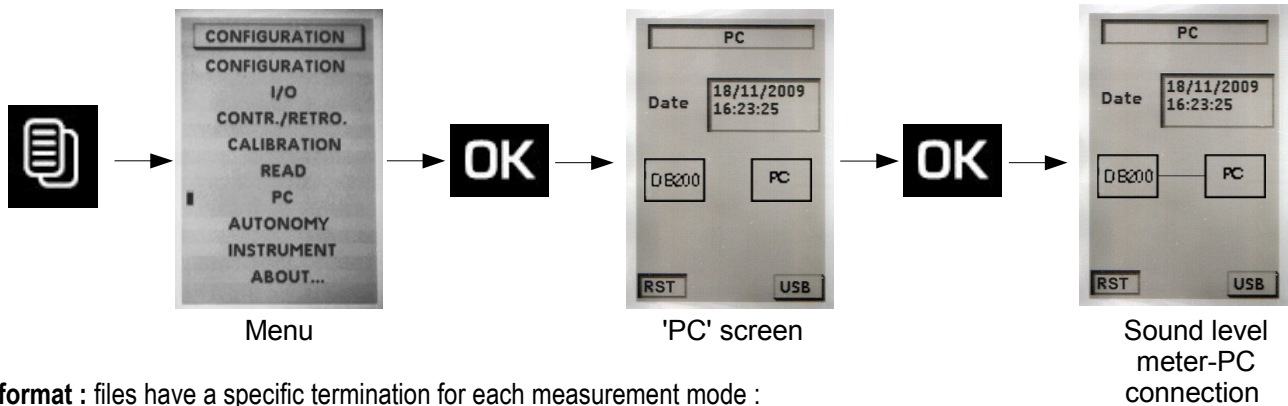

File format : files have a specific termination for each measurement mode :

- **L-St mode** : S01_2409LPF
- **L-Leq mode** : S05_2409LPQ
- **Leq-St mode** : S03_2109LEQ
- **S1+S2 mode** : S04_2409LS1

With **S01** : order number ; **2409** : day month ; **LPF** : extension

VIII – Reset memory

After datasets storing thanks to the transfer to computer, it's possible to erase sound level meter memory. There are two methods :

- Through sound level meter (see below)
- Through computer (see **LDB200** software user manual)

Through sound level meter

- Go to « PC » screen of the sound level meter : from the menu icon, select **PC** then **OK**.
- Move the cursor to **RST** with left arrow key.
- Press **OK** key, **RST** blinks.
- Press **OK** key to delete all data, progress bar is displayed.

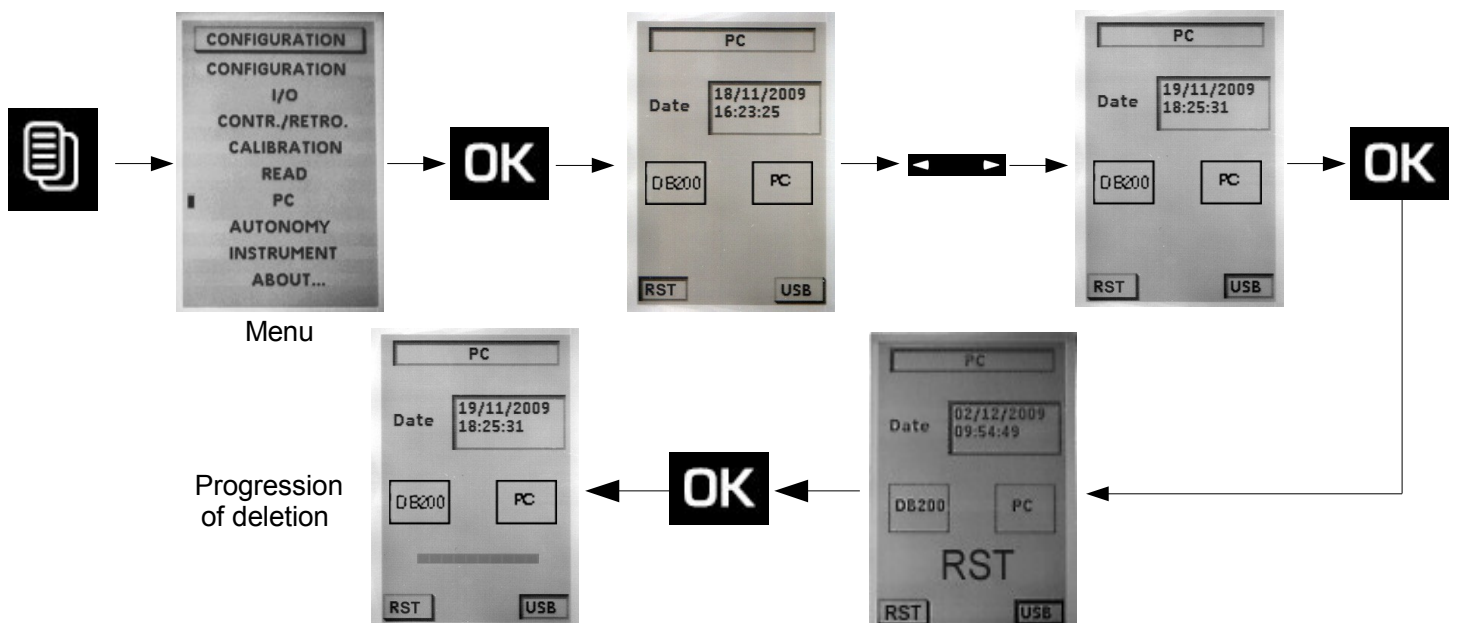



All the sessions in the sound level meter will be permanently deleted.

› Press **Esc** key to quit this file and back to file selection main screen.

IX – Directions for use and sound level meter maintenance

IX 1 – Use warnings

The sound level meter is a measuring instrument using the latest technologies. To maintain accuracy and required reliability, avoid any chock of the housing and the microphone and keep them away from humidity and corrosive steams.

IX 2 – Directions for use

For each application you should check measurement technique and conditions in order to get valid and coherent results. The way of using the instrument has at least as much importance on result than device quality. You have to take into account at least the following parameters :

- The sound level meter is designed for a free-field acoustic measurement
- The instrument is held with reached out arm for short-time measurement or positioned on a tripod for long-time measurement.
- The axis of the instrument must face sound source, do not interfere with your own body or with any close material item (furnitures, machines, low wall, trees, etc...).
- Protect the instrument from bad weather, and use as much as possible the windscreen. It protects the microphone and minimizes during measurement the disruptive effects linked to air currents.
- Calibrate the instrument regularly with a suitable calibrator CAL200 type.

IX 3 – Calibration

A calibration must be performed regularly with a suitable calibrator.

- Insert the adapter ring according to the diameter of the microphone sound level meter.
- Place the calibrator on the microphone, until the microphone reaches the end of the ring. Do this move slowly and smoothly so as not to damage the microphone.
- Put vertically the sound level meter and the calibrator.
- Turn on the calibrator.
- Wait for a moment a correct level of acoustic pressure of the calibrator : for example 94.0 dB .
- You can begin the procedure of calibration of the instrument as explained below.



> **Reminder : Free-field coefficient.**

An acoustic reference source, a calibrator or a pistonphone supplies a level of acoustic pressure. During a free-field measurement, phenomena of diffraction caused by the microphone and the housing come to affect the measurement. This perturbation is minimized if the microphone is far from the housing. For this sound level meter, the induced free-field perturbation is very low, and it is not necessary to introduce a free-field correction.

> **Operating mode**

- Press  key then select **CALIBRATION** with scrolling knob key and press **OK** to validate.

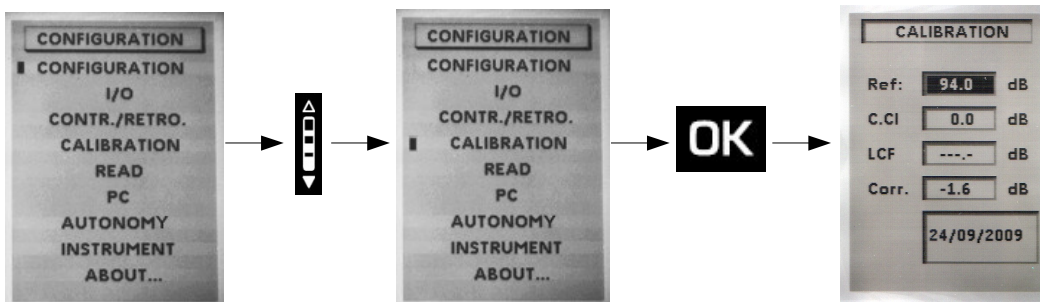

A new screen is displayed :

- Check that the reference value **Ref** : corresponds to that of the used calibrator and the value free-field correction C.CI (0,0 dB for the sound level meter).
- Place the running calibrator on the microphone.
- Move the cursor with arrow keys on **LCF**.

The instrument automatically adjusts the gain of the channel to obtain the coincidence of the levels displayed in Ref and LCF.

When measurement is stabilized, a pictogram **Cal.** appears to validate through **OK** key.

At this moment the correction value of the gain and calibration date are memorized and visible for the next calibration..

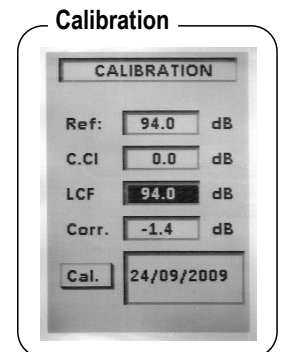

- Quit calibration function par with  key .



This correction can not exceed **+/- 2 dB**. If the correction exceeds **+/- 2 dB**, the coincidence values in **Ref** and **LCF** is not obtained. Reasons of this difference shall be identified (defective microphone, level value of the calibrator not adapted...).

> **Modification of the reference value**

The reference preset value during manufacturing process shows that we use calibrator with rated value of 94 dB at 1000 Hz. If the proposed reference is not the one of the available calibrator, follow the instruction below :

- Move the cursor on **Ref**. With arrow keys  . Adjust to the desired value dB per dB with scrolling knob key  .

This new value is memorized until the next change.

IX 4 – Maintenance

The sound level meter conception allows a reduced maintenance which consists in changing batteries and cleaning the instrument with a slightly cloth. A particular attention must be paid to the microphone sensor, which is the element the most sensitive of the metrological chain.

IX 5 – Regular checking

Like most measuring instruments, it is strongly recommended to regularly control and calibrate DB200 instrument. Return to the manufacturer each year will provide necessary metrological traceability.

IX 6 – Change batteries

- **Turn off the sound level meter.**
- Return the instrument.
- Open the back hatch.
- Keep off the 3 batteries and insert the 3 new batteries of type 1.5 V / AAA-LR3 inside. Respect meaning of batteries.
- Close the back hatch.

IX 7 – Replace the batteries with a battery pack

According to the frequency of use of the instrument, it is sometimes better to replace batteries power by a rechargeable Li-ion battery. The battery life increases to nearly 30 hours of continuous operation.

- **Turn off the sound level meter.**
- Remove the battery pack located inside the housing and disconnect the associated connector.
- Connect the battery respecting its insertion direction (mechanical keying of security).
- Slide the battery into the housing.
- Close the back hatch

IX 8 – Load the battery

Use a USB power adaptor which serves as a charger.

It's also possible to connect the sound level meter to USB port of a running computer. Battery will load according available current at the USB output, about 500 mA.

A time of about 8 to 10 hours is needed to obtain a full charge.

Meaning of warning light located next to USB port :

- **Red warning light** : ongoing load
- **Green warning light** : completed load
- **Blinking red /green warning light** : battery is disconnected, check the connection or contact customer support
- **Orange warning light after a load period** : load or battery trouble : disconnect then connect again the charger. Red warning light must be turned on to finish loading. If orange warning light appears, contact customer support.

IX 9 – AC adapter

For measurements over long periods, if possible, use the AC adapter supplied with the instrument. Battery pack (or optional battery) must stay inside the instrument in order to preserve measurement in case sudden failure of the sector.

X – Running informations

X 1 – Over-range

Under conditions of measuring range excess, defined at **133,5 dB**, Z peak, an over-range icon appears. Its displaying differs with the measuring mode selected:

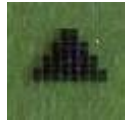

• L and L-St modes :

- LXY : it comes fleetingly for each passing. It stays visible at least 1s for a better readability.
- LXpk : warning light appears during the first overload of the input stage, it stays visible during all the measurement.
- LXY max and LXY min : the presence of the warning light indicates that displayed minimum and maximum values have been overloaded.

Deletion of overload warning lights takes place during a controlled reset by keyboard.

• L-Leq mode :

- LXY : it comes fleetingly for each passing. It stays visible at least 1s for a better readability.
- LXpk et Leq : warning light appears during the first overload of the input stage, it stays visible until the end of the measurement. (24H maximum)

• Leq-St Mode :

- Leq 0,5s : warning light appears for each overload of input stage, it stays visible during the integration time of 0,5s, then switches off and so on...
- Leq, DI and LXpk : both warning lights appear for each input stage, they stay visible during the integration time (from 1s to 60s), then switch off and so on...
- Leq, T : warning light appears during the first overload of the input stage, it stays visible until the end of the measurement.

• S1+S2 mode :

- warning light appears at the first overload of input stage for each measurement, it stays visible until the end of the measurement.

• % of presence of overloads of the input stage :

This information can be required during a mid and long term measurement, when overload indicator is displayed. Its presence does not provide information about the frequency of occurrence of the overload but the percentage calculation provides a level of alert about measured and displayed levels by the instrument.



A LXY minimum value may have been overloaded, for example a level of 110 dBA with a high peak factor, while a LXY maximum value of 125dBA with a low peak factor can not be overloaded.

X 2 – Power

When the instrument is equipped with alkaline batteries or with a battery, a symbol informs the user about the remaining power. In case of low power, less than one bar on the pictogram, the pictogram starts blinking, the instrument stops the measurement, saves the results and switches off.



During a mains connection for long term measurements, the pictogram automatically changes to represent a plug.



In case of sudden failure of the sector, the measurement is not saved. To avoid this trouble, let the batteries or the rechargeable battery inside the instrument.

XI – Technical features

XI 1 – Microphone

The instrument is equipped with an electret microphone with an integrated preamplifier of standardized diameter of ½ inch. Fixed at the top of the sound level meter, it gives to the group (microphone and housing) free field features compatible with standards.

XI 1-1 – Sheet

- Marque : KIMO
- Type : Prepolarized free-field ½"
- Grig diameter: 13.2 mm
- Preamplifier : integrated
- Power : 15 V DC
- Nominal sensitivity for preamplifier output : 50mV/Pa
- Equivalent capacity : about 10pF

XI 1-2 – Frequency response type – reference direction of the sound level meter

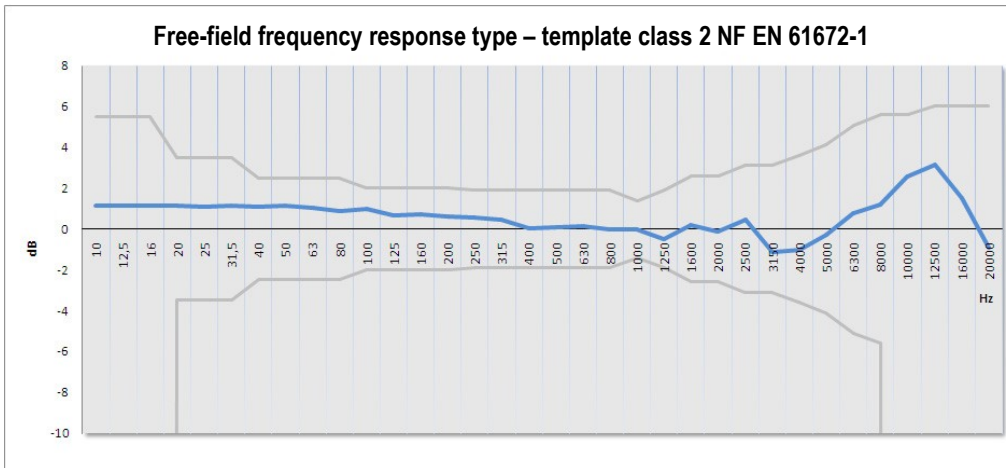

XI 2 – Windscreen

B-DB23 windscreen creates modifications of free field response that comes in addition to initial features of the microphone on the housing. The whole stays compliant to requirements class 2 reference standard. So, when using the windscreen, there is no need to take into account a correction term free field.

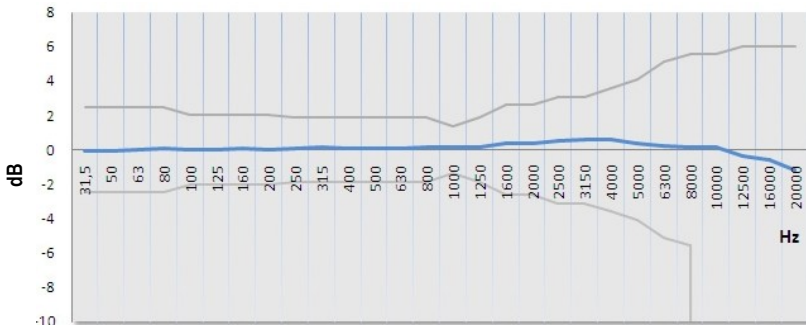

**B-DB23 free field response –
template class 2 NF EN 61672-1**

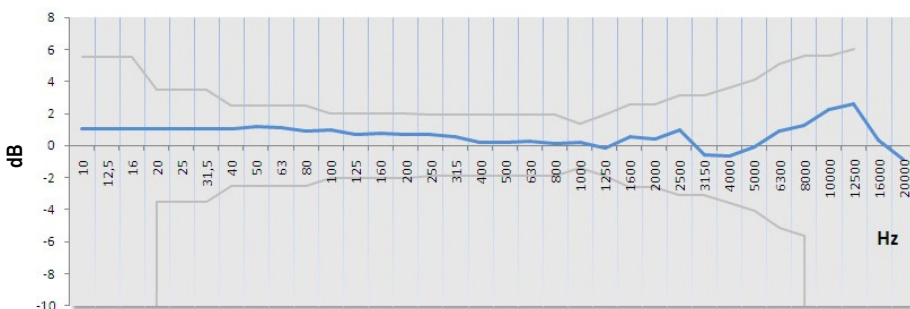

**Free field response microphone type +
B-DB23 – template class 2 EN NF 61672-1**

XI 3 – Measured and displayed values

- A, C or Z- weighted frequency acoustic pressure level and temporally weighted according time weightings : Slow, Fast or Impulse. E.g. : LAF.
- A, C or Z- weighted frequency maximum acoustic pressure level and temporally weighted according time weightings : Slow, Fast or Impulse on a measurement time. E.g. : LAFMax
- A, C or Z- weighted frequency minimum acoustic pressure level and temporally weighted according time weightings : Slow, Fast or Impulse on a measurement time. Ex : LAFmin
- C or Z weighted frequency peak pressure level. Ex : LCpK
- Equivalent continuous level of acoustic pressure, A, C or Z weighted frequency on a T time measurement. Ex : LAeq,T ou LAT
- Equivalent continuous level of acoustic pressure, A, C or Z frequency weighted on a DI elementary measurement time. Ex : LAeq,DI
- Equivalent continuous maximum level of acoustic pressure, A, C or Z frequency weighted on DI elementary measurement time met on the total measurement Ex : LAeq,M
- Equivalent continuous minimum level of acoustic pressure, A, C or Z frequency weighted on DI elementary measurement time met on the total measurement Ex : LAeq,m
- Level of sound exposure A, C or Z frequency weighted on a T time measurement related to reference time of 1s. Ex : LAE

Statistical indices :

Definition : When the sound level fluctuates, the distribution of the measured levels can be characterized by statistical indices. These are statistically calculated from the time evolution of the sound level measured in-site. These levels correspond to X-weighted acoustic pressure level which is exceeded for N% of the time interval. It is noted LN.

Therefore, the statistical indice L1 corresponds to sound level exceeded for 1% of the observation time, L50 for 50% of the time. Calculated indices are : L01 – L10 – L50 – L90 – L95

XI 4 – A – C – Z weightings and free field response

The frequency response of the whole microphone / windscreen / A, C or Z weightings (sound level meter) is in compliance with standards in a given template according the accuracy class of the instrument : NF EN 61672-1 / class 2.

Plots types of free field sound level meter are given below :

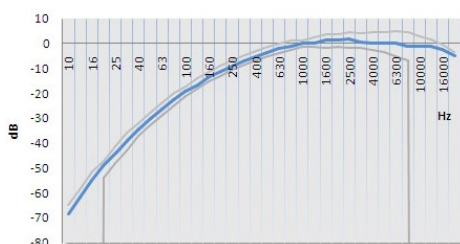

Free field response with A weighting



Free field response with C weighting

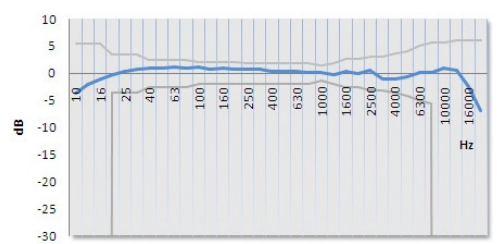

Free field response with Z weighting

XI 5 – Metrology**XI 5-1 – Main features**

DB200 sound level meter	Classical mode	Integrator – averager mode
Electromagnetical compatibility – CE mark	As per 89/336/CEE directive and product standards	
Standards	NF EN 61672-1 (2003)- NF EN 60651 (1994)	NF EN 61672-1 (2003)- NF EN 60804 (2000)
Accuracy class	2	
Reference		
Pressure level	94dB	
Frequency	1000 Hz	
Caliber	30-130 dB	
Direction	0°: microphone axis	
Measuring range		
A Weighted	30-130 dB	
C Weighted	35-130 dB	
Z Weighted	35-130 dB	
Peak channel measuring range	83-133 dB	
Resolution	0.1 dB	
Sound referred to input	Compatible with the linear range	
Frequency weighting X	A – C – Z	
Frequency weighting Y	Fast (F), Slow(S), Impulse (I)	
Overload indicator (min)	133,1 dB	
Controlled elementary integration time of LXeq for storing		1s, 2s, 3s, 5s, 10s, 15s, 30s, 60s
Sampling rate of LXY for storing	1s, 2s, 3s, 5s, 10s, 15s, 30s, 60s	
Free integration time – Start/Stop (max) order		24H00
Statistical indices LXN	Calculation based on LXY or LXeq,DI stored data, rounded up to the next dB on a dynamic of 100 dB	
Clock Accuracy	Better than 0.01 %	
Reference environment	23°C – 50% RH – 1013 hPa	
Operating environment	From -10°C to +50°C / 650 hPa to 1080 hPa / 25% to 90% FH	
Storage temperature	From 0°C to +50°C	
Dimensions (L x l x e)	270 x 70 x 40 mm	
Weight (with batteries)	280 gr	
Fixing	Fixation on the back of the instrument for tripod	

XI 6 – Plugs and connections

Located under the breastplate in soft rubber, the different plugs and connections stand for :

- Communication with external components : I/O interface
- Battery load (optional) and/or power
- Access micro SD card.

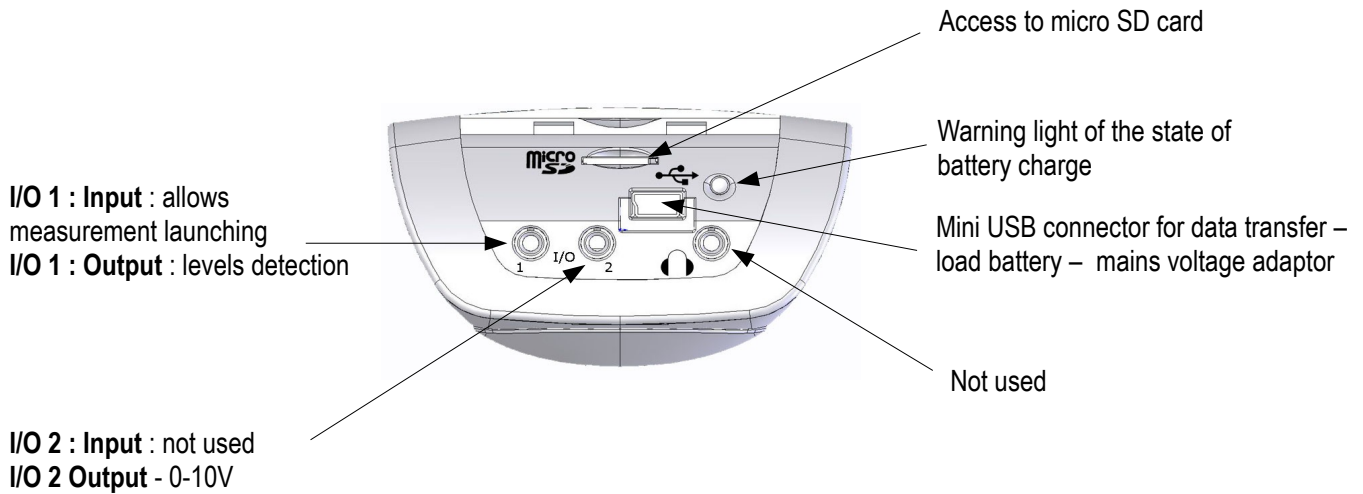

XI 6-1 – I/O Interface

I/O 1 In - input : start-stop control for measurement :
 TTL level maximal 5V – input impedance > 15 kΩ – jack : 2,5 mm diameter



I/O 1 Out- output :to activate alarm - maintains high state after detecting a LX or planned LXeq level . Variable time selected from 1s to 10s by 1s steps.
 TTL level 3.3 V – input impedance < 100 Ω - jack : 2,5 mm diameter

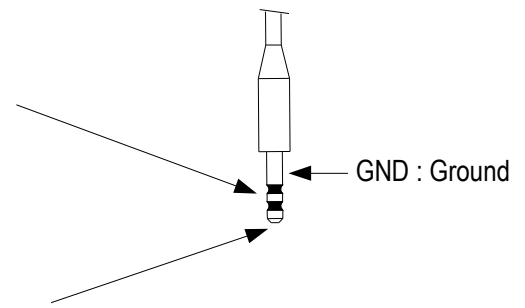

I/O 2 Out : DC output : 0-10 Volts – input impedance < 100 Ω - jack : 2,5 mm diameter
 dynamic range 0-130dB
 step : 0,0769 mV/dB
 accuracy : ± 0,3dB

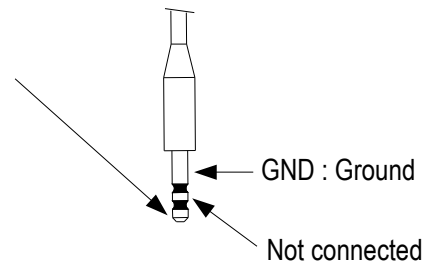

XI 6-2 – Transfer plug / load / mains voltage adaptor

This plug is for data transfer, battery load (optional) or power. It's a mini USB format.

- **Data transfer** : USB mode
- **Data Format** : proprietary

- **Mains supply – charger** : type universal USB format – ref : **AS-123**
 PRI : 100V-240V-60/50Hz – 150 mA
 SEC : 5V - 1000mA - 5VA

XI 7 – Memory and storage autonomy

- **Memory** : micro SD card type, it takes place in the slot on the back of the unit. It allows **25 sessions** of **86500** values each.
- **Capacity** : microSD Card – **1GB** or **2GB**

Table below shows the measurement time (1 session) according logging time (sampling rate) for LXeq (LXY) storage.

Integration time or sampling rate	Maximum measurement time (in hours)	Maximum measurement time (en days)
1s	24	1
2s	48	2
3s	72	3
5s	120	5
10s	240	10
15s	360	15
30s	720	30
60s	1440	60



In the event of a reset of the memory by the sound level meter or through the software LDB200, all the memory is erased.

XI 8– Power and storage autonomy

Measurement autonomies linked to power are given for a running at 20°C and backlight off. Beware of declining capacity of the battery or batteries for measurement at low temperature.

- **Batteries pack** : 3 alkaline batteries 1,5V – LR6/AA type
Autonomy (20°C) : 15H in continuous

- **Battery** : rechargeable Li-Ion type : 3,7 V – 4400 mAh.
Caution : Li-Ion battery is a delicate element. Take care when manipulating or storing.
Autonomy (20°C) : > 24H in continuous

- **Mains supply – charger** : type universal USB format – ref : **AS-123**

PRI :100V – 240V - 60/50Hz – 150 mA

SEC : 5V - 1000mA - 5VA

Autonomy : unlimited, depending on memory capacity of the measurement (see table above).



When a connection to a PC for data transfer, the USB computer delivers a voltage of 5V DC 500mA under. This power supply has priority over the battery pack or battery that is recharged through this power supply.

XII – Packaging and accessories

XII 1 – Supplied with

The sound level meter is supplied in a transport case with a batteries pack (3 x LR6/AA), a windscreen, a USB cable for transferring data, a CD-ROM with LDB200 software and user manuals. A calibration certificate is also supplied.

XII 2 – Optional

- Acoustic calibrator class 2 type : **CAL200**
- Rechargeable Li-Ion battery and charger – mains adapter USB type : **BL-I23**
- Mains adapter : **AS- 123**
- Telescopic tripod : **PPCX**
- Jacks cables I/O interface : on request

XIII – LDB200 software

Supplied with the sound level meter, **LDB200** software allows the configuration, data recovery and exploitation stored in the memory of the instrument.

Easy to use, it requires a smaller learning and allows immediate management of data.

Main functions :

- Visualization and results of the different measurement mode
- Zoom function for more detailed study of a period
- Statistical distribution of data
- Formatting and editing of measurement report.
- Data recovery and creation of text files.

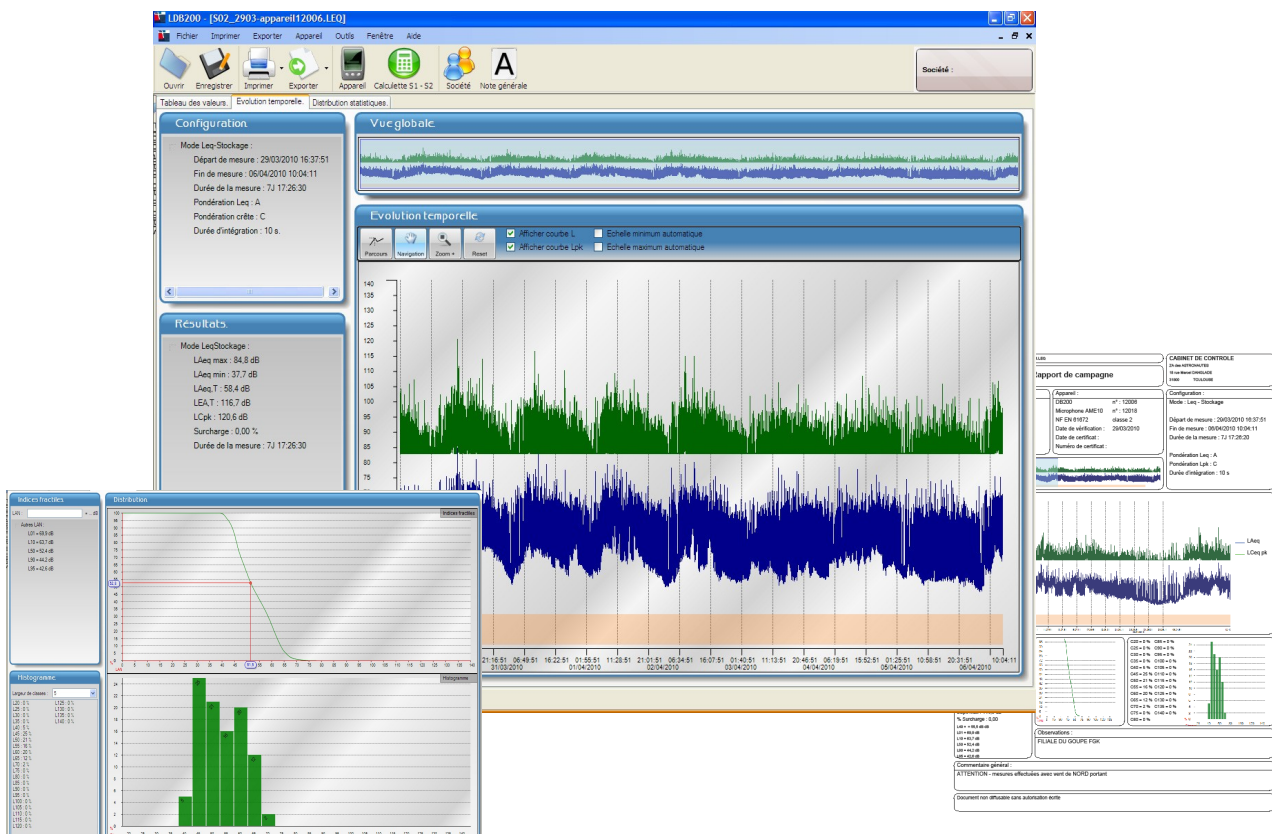

www.kimo.fr

EXPORT DEPARTMENT

Boulevard de Beaubourg - Emerainville - BP 48
77312 MARNE LA VALLEE CEDEX 2

Tel : + 33.1.60.06.69.25 - Fax : + 33.1.60.06.69.29

